

FastGuard 20

H1620mm ASSEMBLY INSTRUCTIONS

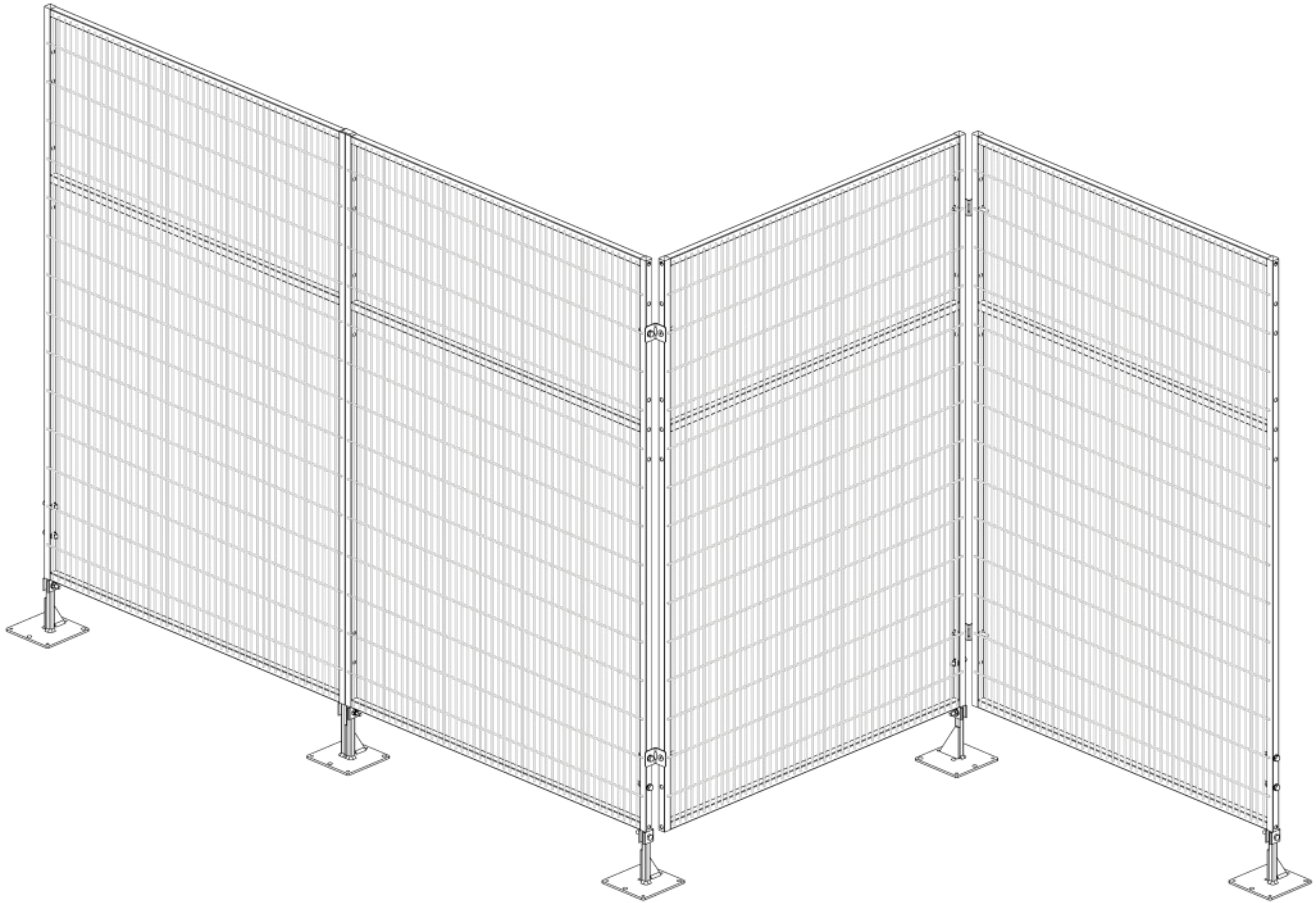
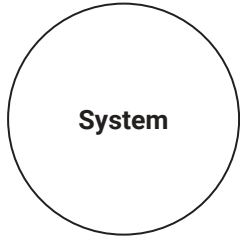

FastGuard 20

SAFE START

1

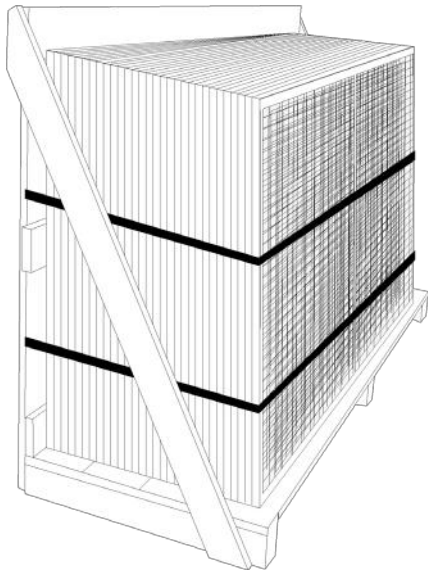

2

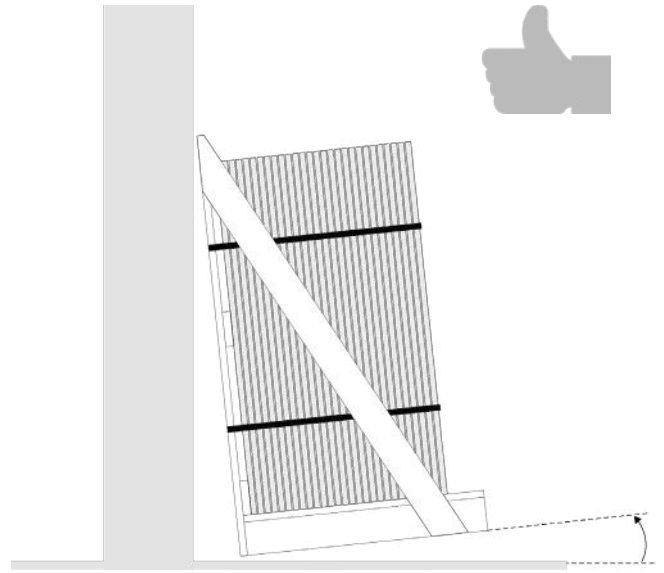

3

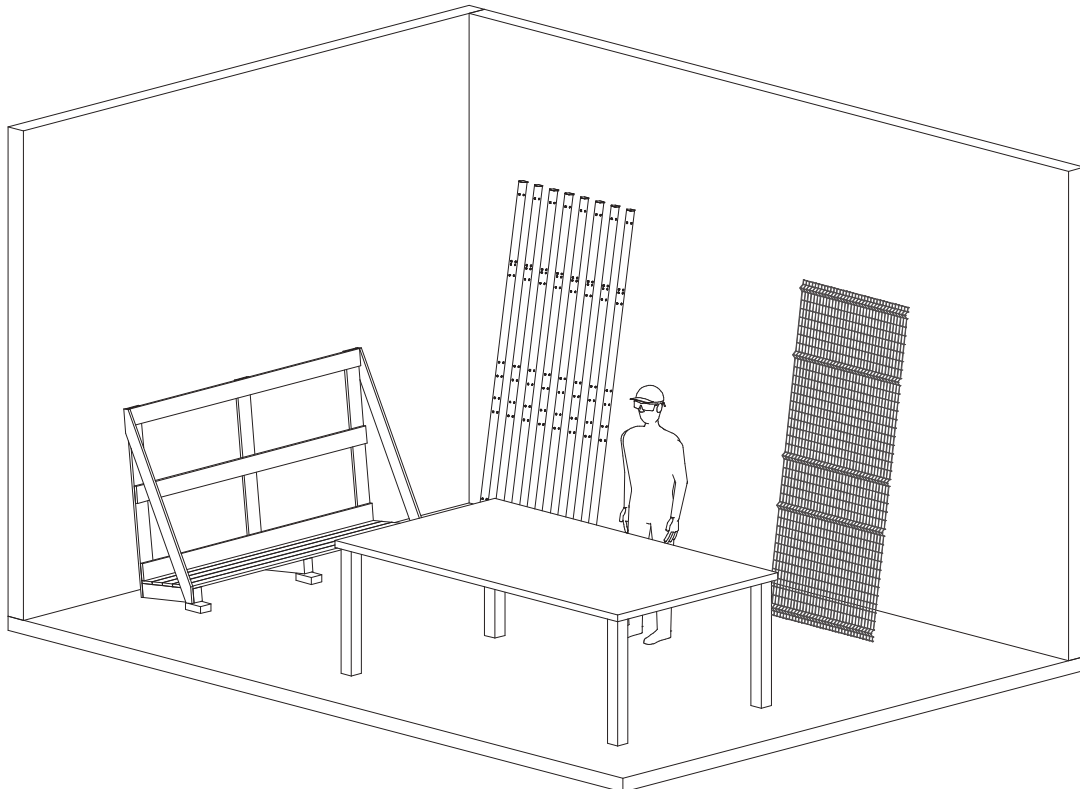

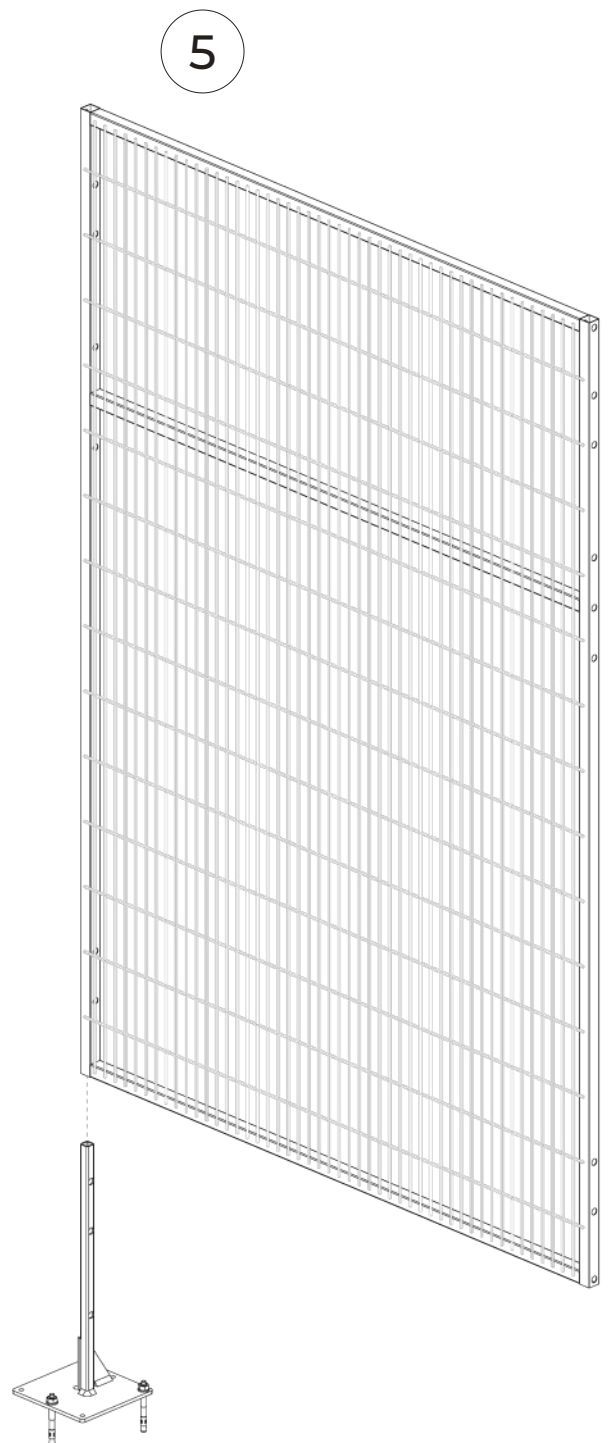
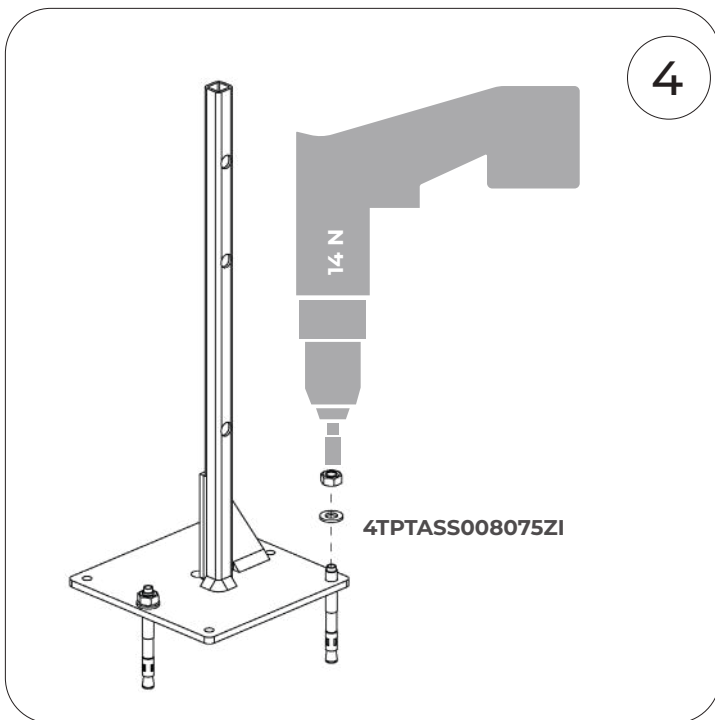

FastGuard 20

H1620mm ASSEMBLY INSTRUCTIONS - LINEAR

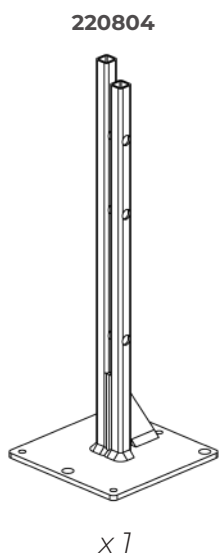

402100000000001

ISO 4017 M8 X 30



x1

ISO 7089 Ø 8



x1

4TPTASS008075ZI

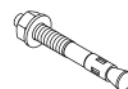

x3

402100000000012

790134



x2

4VEZTFZA008060

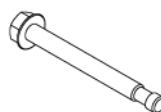

x1

4DAD40B000008ZI



x1

Tools

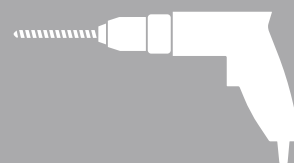
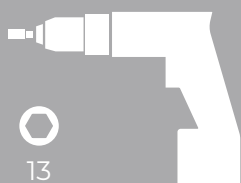

FastGuard 20

H1620mm ASSEMBLY INSTRUCTIONS - LINEAR

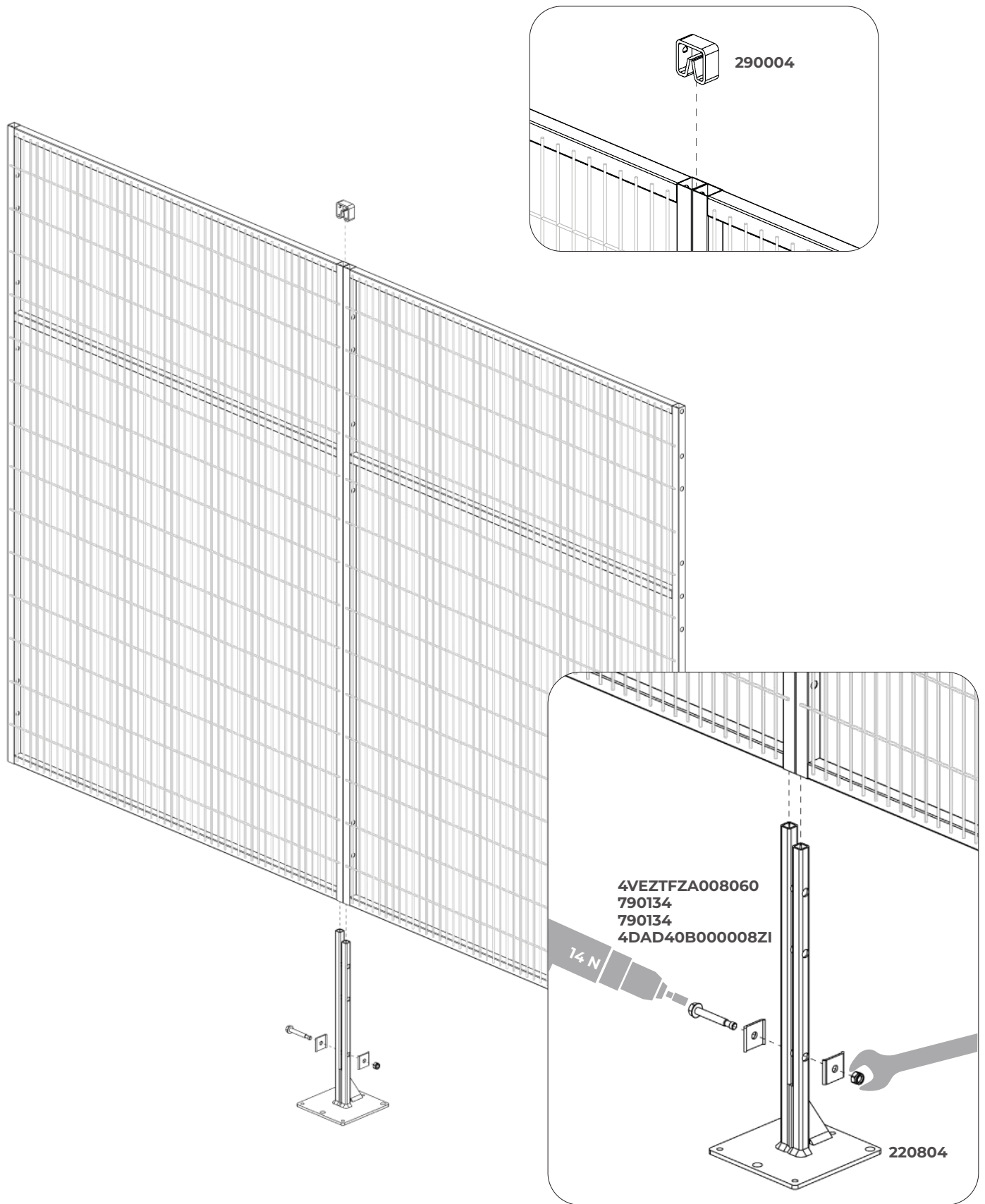

FastGuard 20

H1620mm ASSEMBLY INSTRUCTIONS - TERMINAL

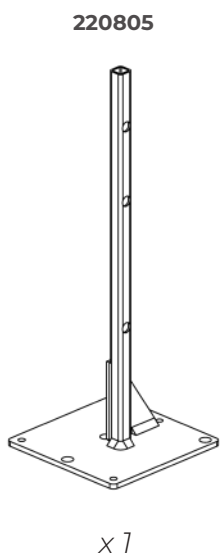

402100000000001

ISO 4017 M8 X 30



x 1

ISO 7089 Ø 8



x 1

4TPTASS008075Z1

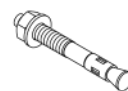

x 3

402100000000011

790134

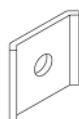

x 2

ISO 4017 M8 X 40



x 3

ISO 7089 Ø 8



x 3

ISO 4161 M8



x 3

Tools

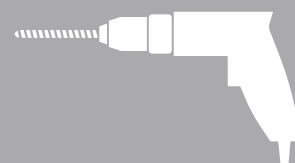
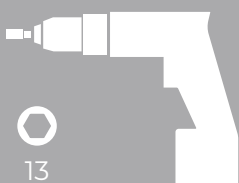

FastGuard 20

H1620mm ASSEMBLY INSTRUCTIONS - TERMINAL

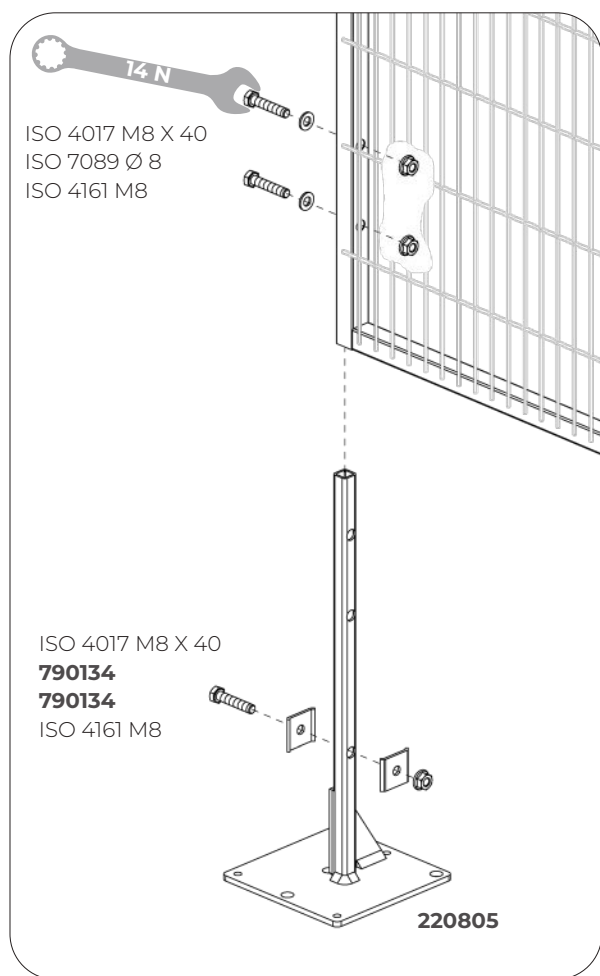
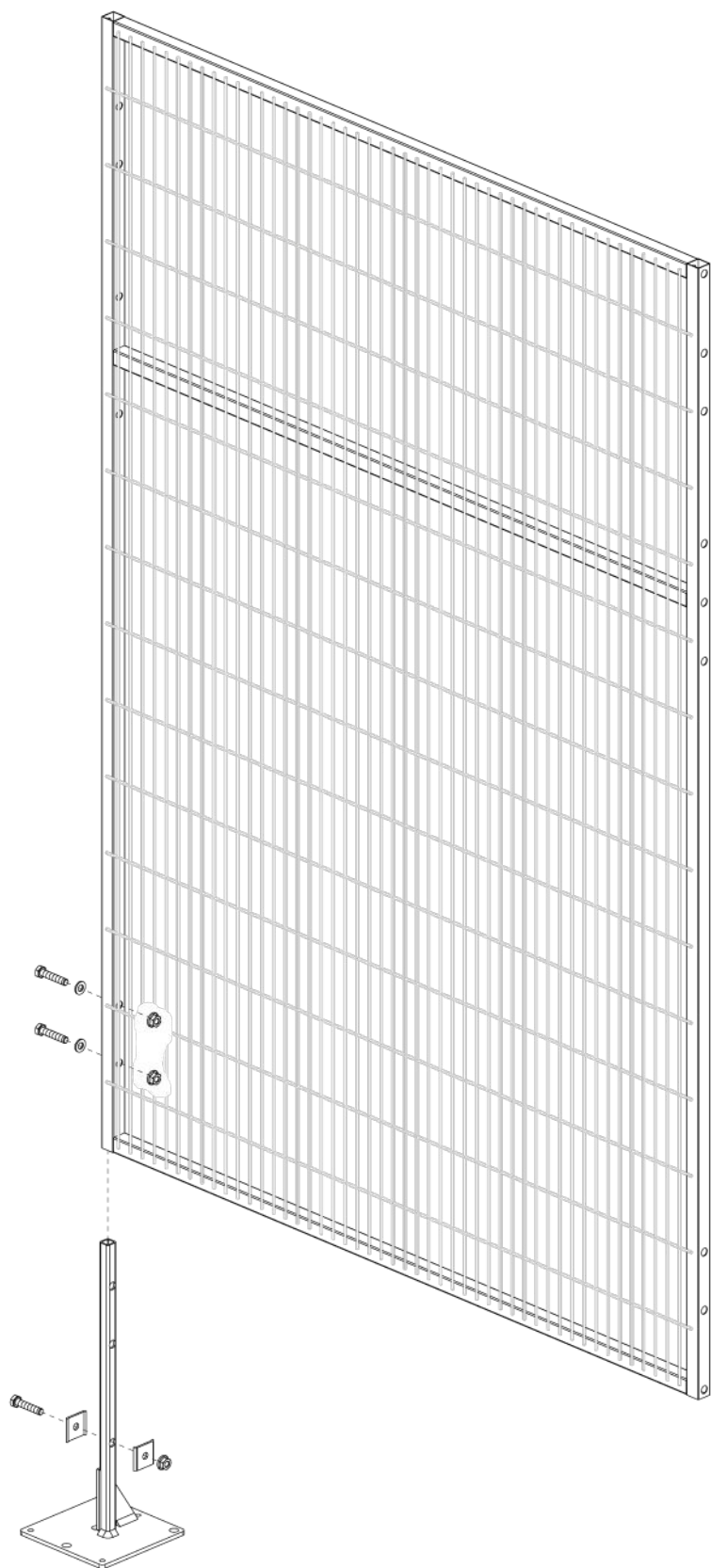

FastGuard 20

H1620mm ASSEMBLY INSTRUCTIONS - ANGULAR / VARIABLE ANGLE

4021000000000001

ISO 4017 M8 X 30



x 1

ISO 7089 Ø 8



x 1

4TPTASS008075Z1



x 3

4021000000000010

190033

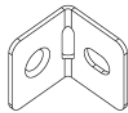

x 2

4DC900160007AZI



x 4

810027A



x 2

ISO 10642 M8 x 50



x 4

4021000000000011

790134



x 2

ISO 4017 M8 X 40



x 3

ISO 7089 Ø 8



x 3

ISO 4161 M8



x 3

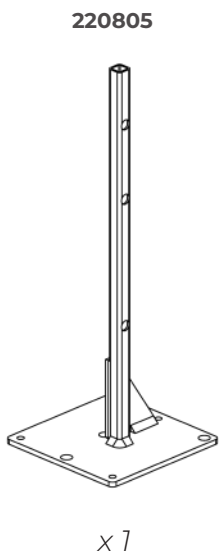

Tools

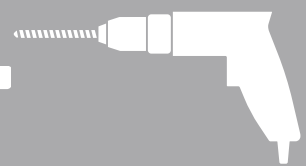
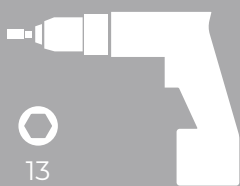

FastGuard 20

H1620mm ASSEMBLY INSTRUCTIONS - ANGULAR / VARIABLE ANGLE

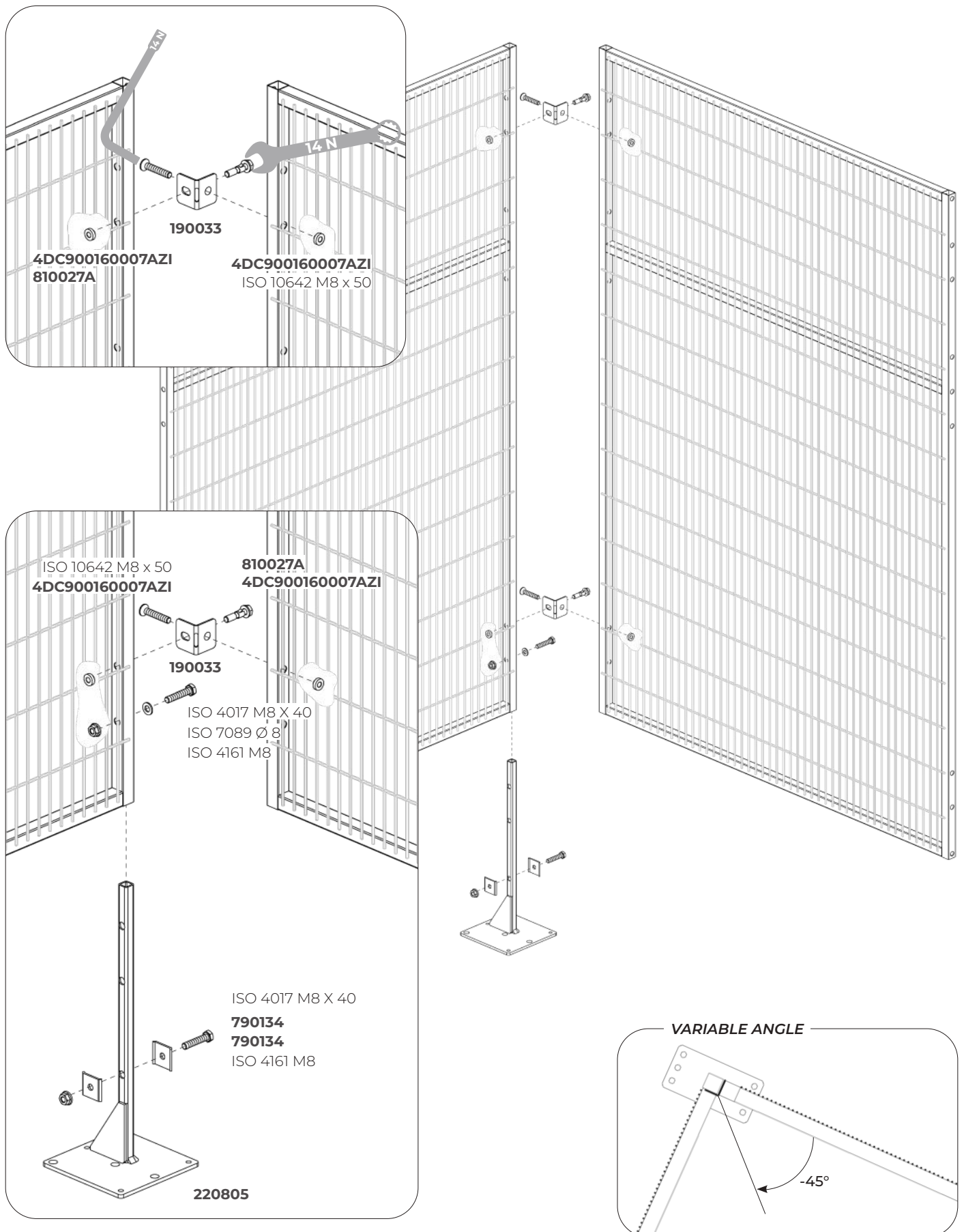

FastGuard 20

H2220mm ASSEMBLY INSTRUCTIONS

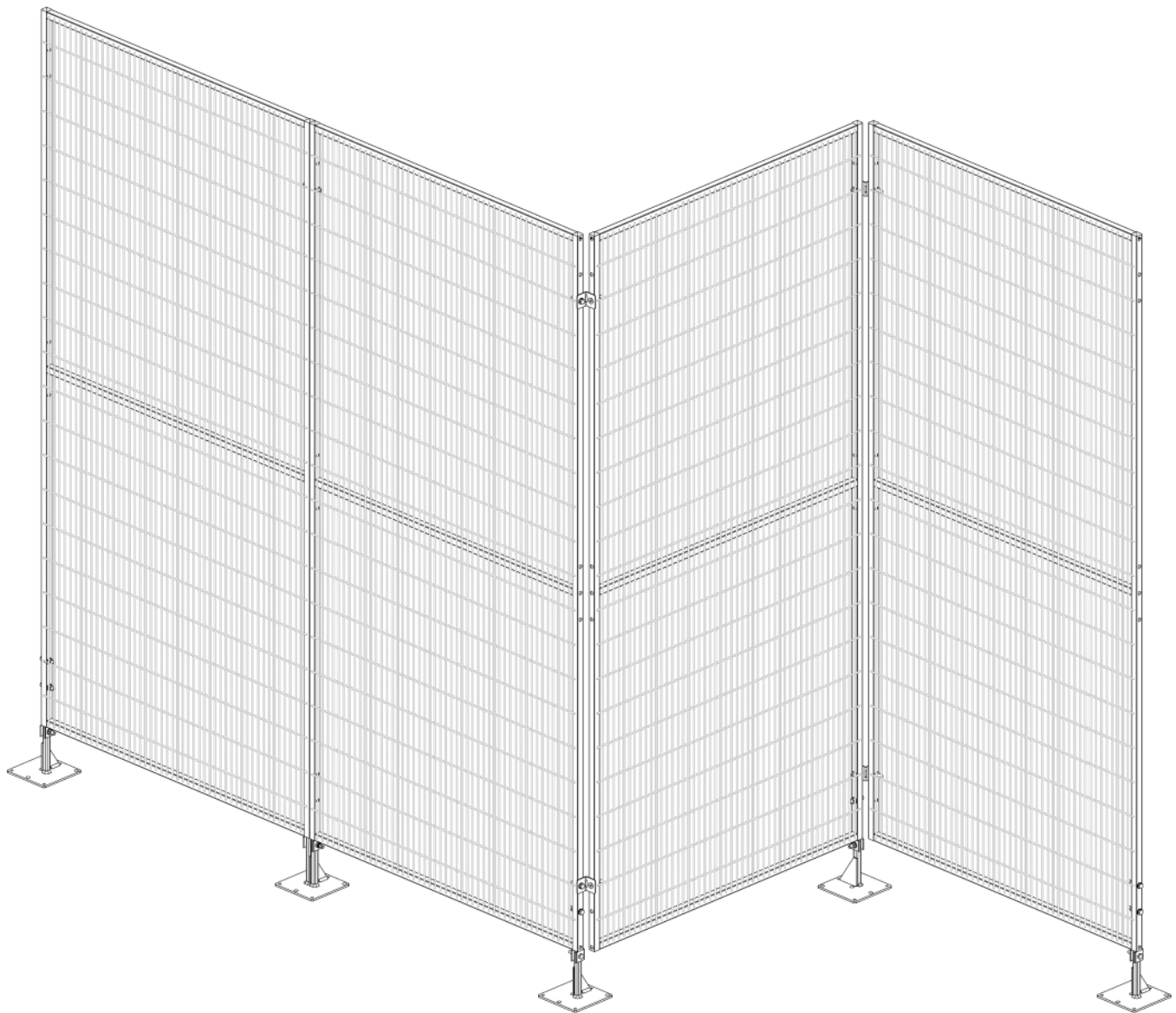
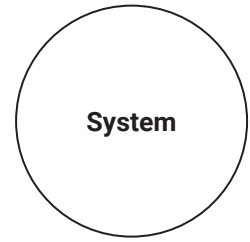

FastGuard 20

SAFE START

1

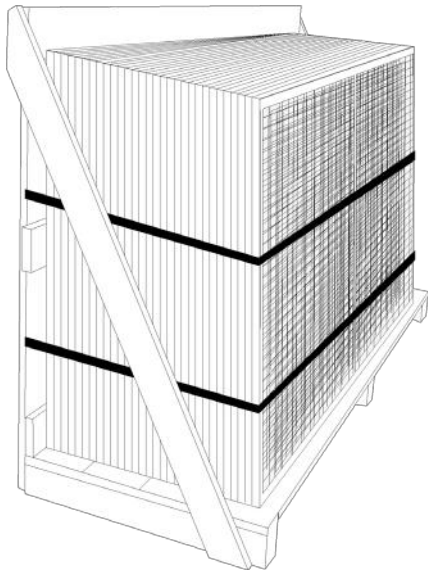

2

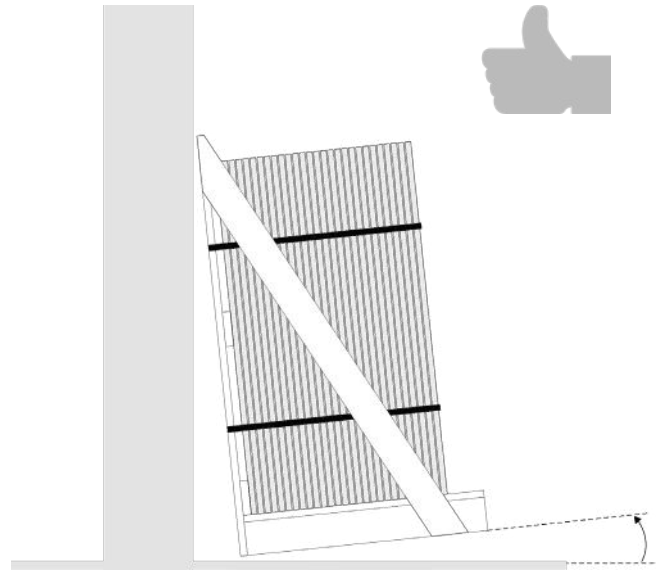

3

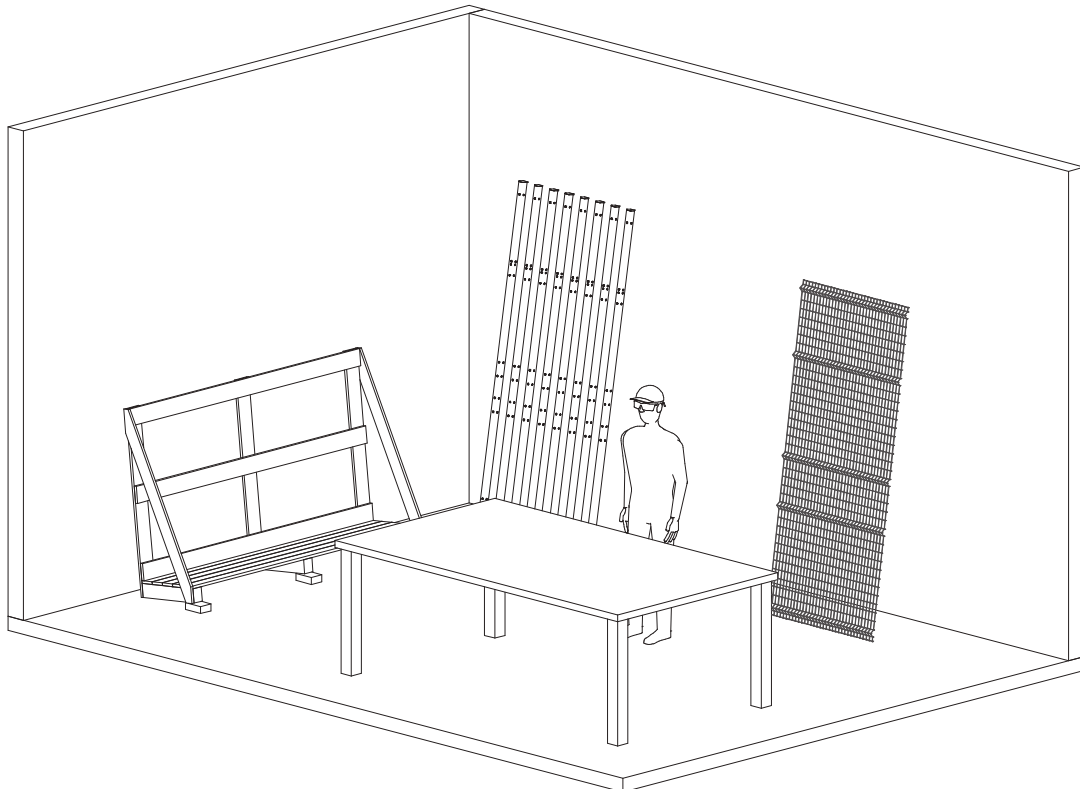

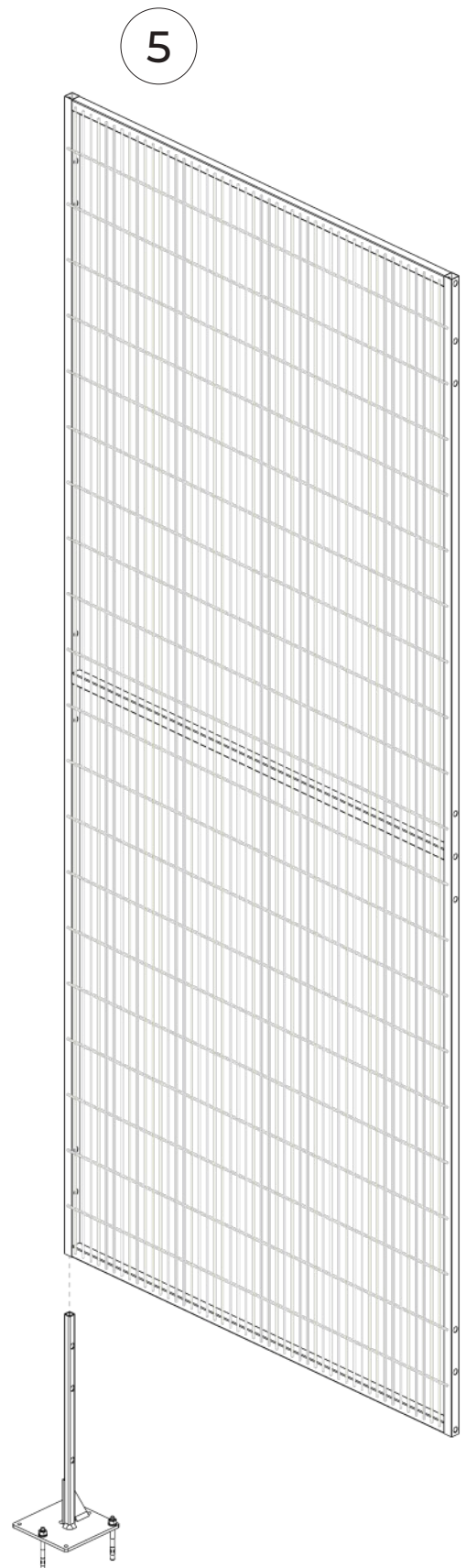
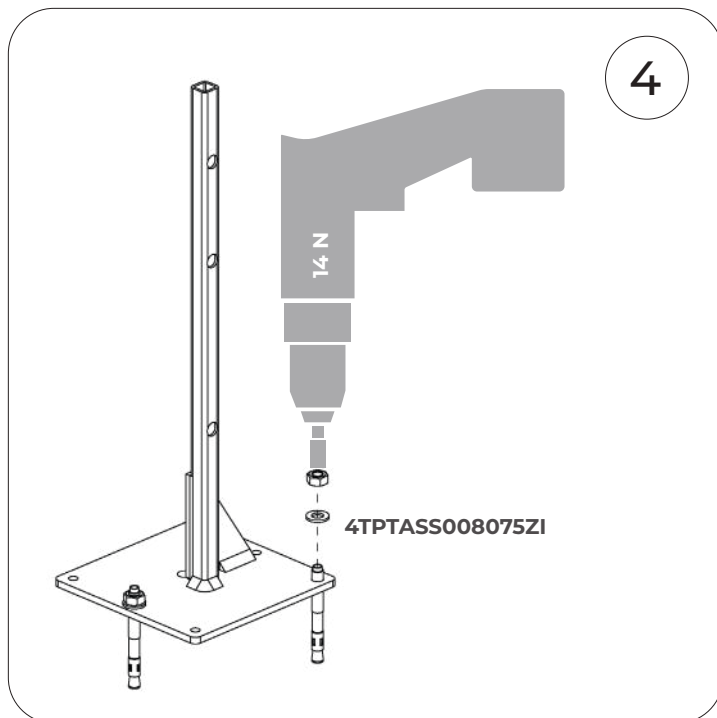

FastGuard 20

H2220mm ASSEMBLY INSTRUCTIONS - LINEAR

402100000000001

ISO 4017 M8 X 30



x 1

ISO 7089 Ø 8



x 1

4TPTASS008075ZI

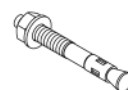

x 3

220804

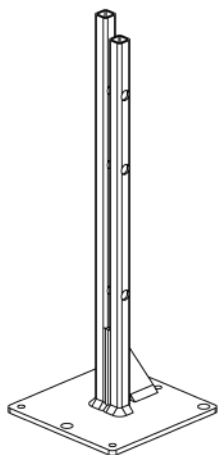

x 1

402100000000002

790134



x 2

4VEZTFZA008060

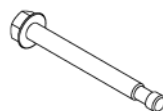

x 1

4VEZE11AB08055A



x 1

4DC900160007AZI



x 1

4DAD40B000008ZI



x 1

Tools

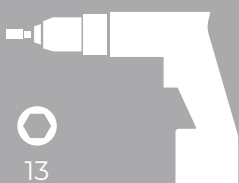

13



13

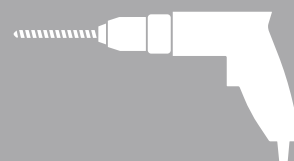

FastGuard 20

H2220mm ASSEMBLY INSTRUCTIONS - LINEAR

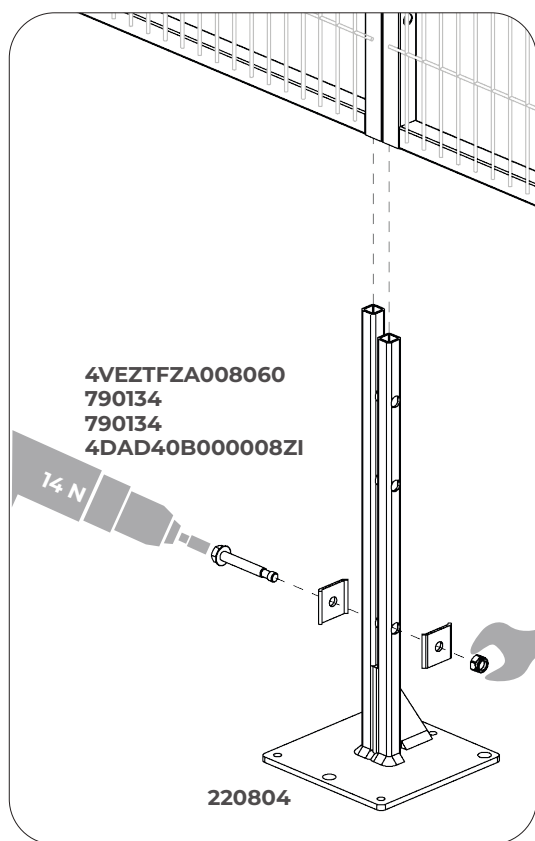
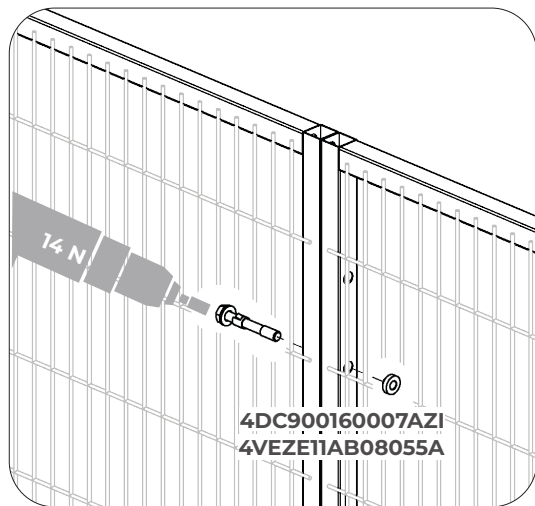
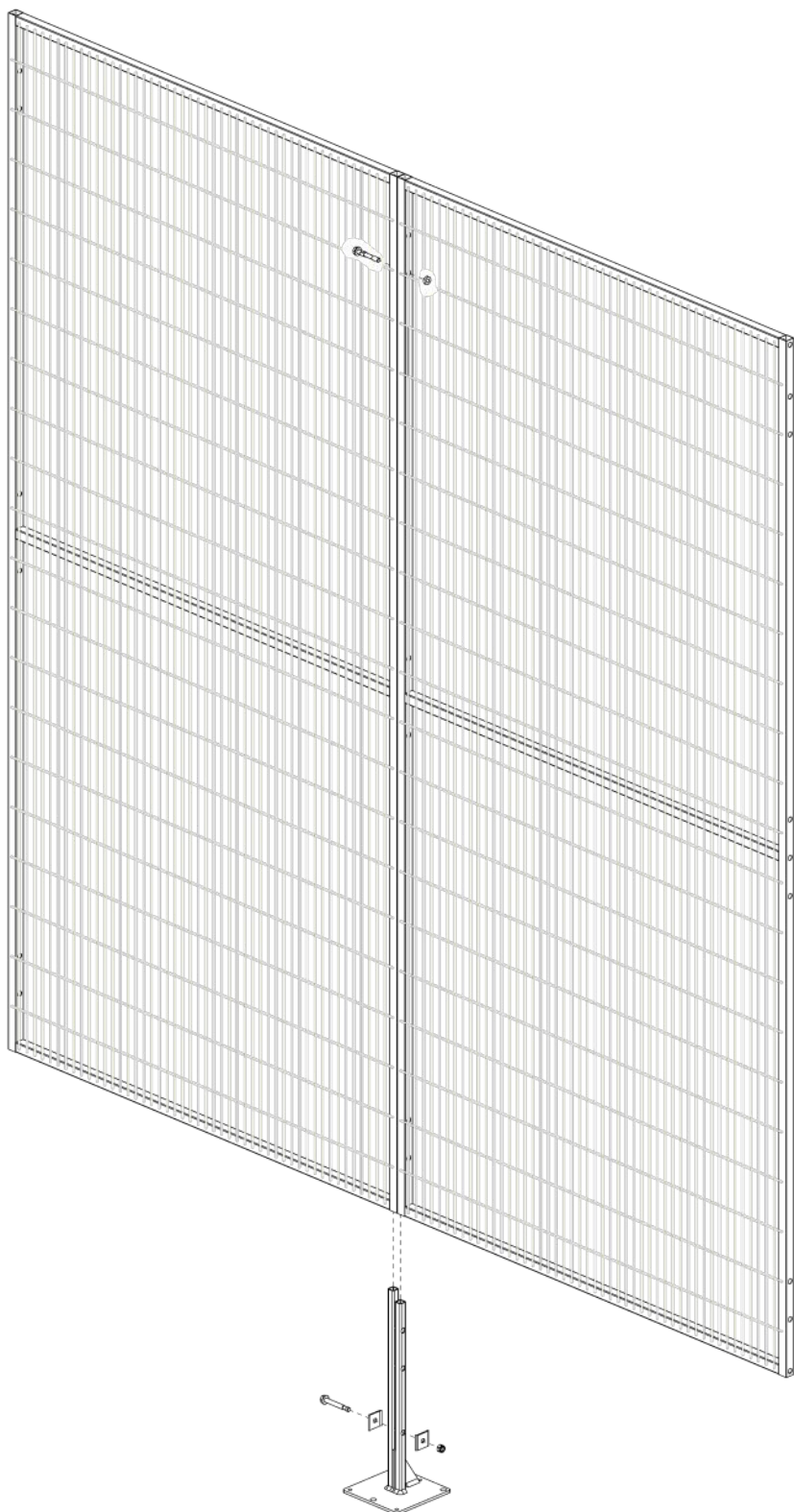

FastGuard 20

H2220mm ASSEMBLY INSTRUCTIONS - TERMINAL

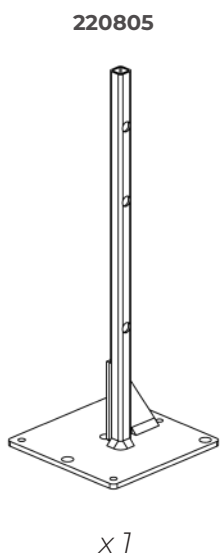

402100000000001

ISO 4017 M8 X 30



x1

ISO 7089 Ø 8



x1

4TPTASS008075Z1

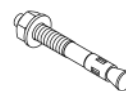

x3

402100000000011

790134



x2

ISO 4017 M8 X 40



x3

ISO 7089 Ø 8



x3

ISO 4161 M8



x3

Tools

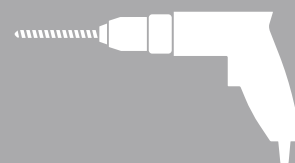
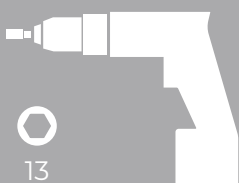

FastGuard 20

H2220mm ASSEMBLY INSTRUCTIONS - TERMINAL

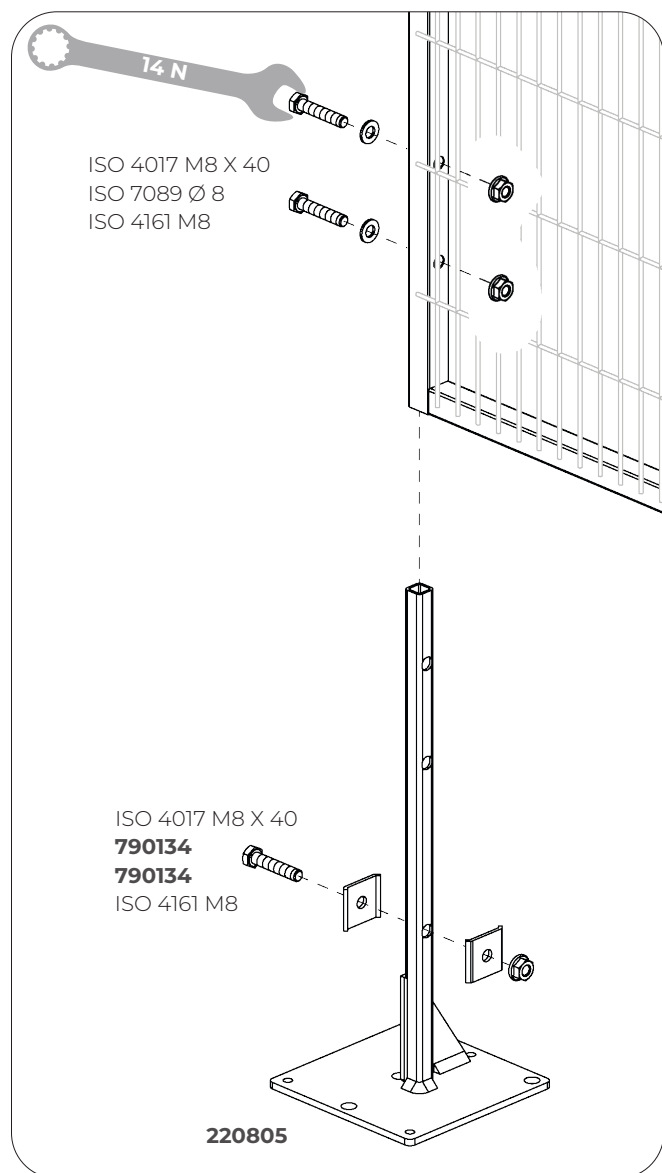
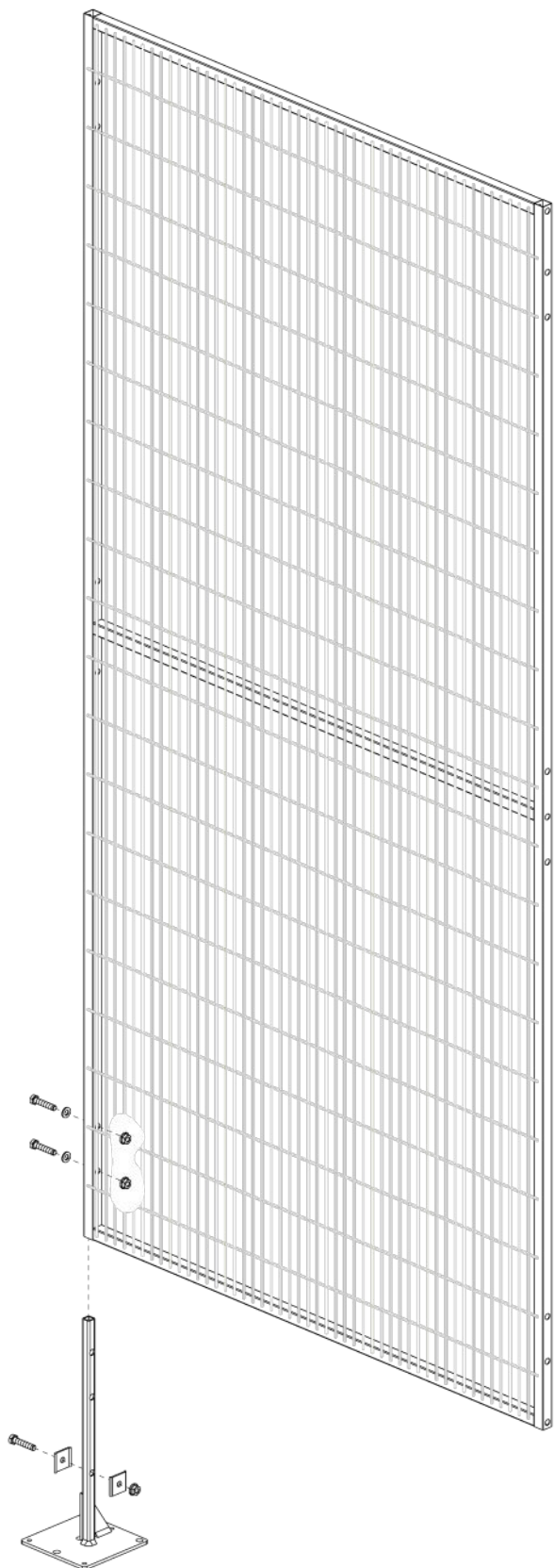

FastGuard 20

H2220mm ASSEMBLY INSTRUCTIONS - ANGULAR / VARIABLE ANGLE

4021000000000001

ISO 4017 M8 X 30

ISO 7089 Ø 8

4TPTASS008075Z1



x 1

x 1

x 3

4021000000000010

190033

4DC900160007AZI

810027A

ISO 10642 M8 x 50

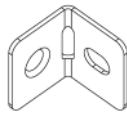

x 2

x 4

x 2

x 4

4021000000000011

790134

ISO 4017 M8 X 40

ISO 7089 Ø 8

ISO 4161 M8



x 2

x 3

x 3

x 3

220805

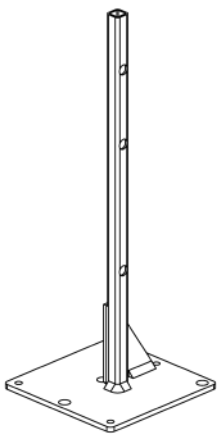

x 1

Tools

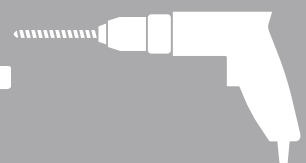
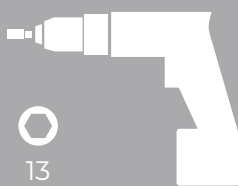

FastGuard 20

H2220mm ASSEMBLY INSTRUCTIONS - ANGULAR / VARIABLE ANGLE

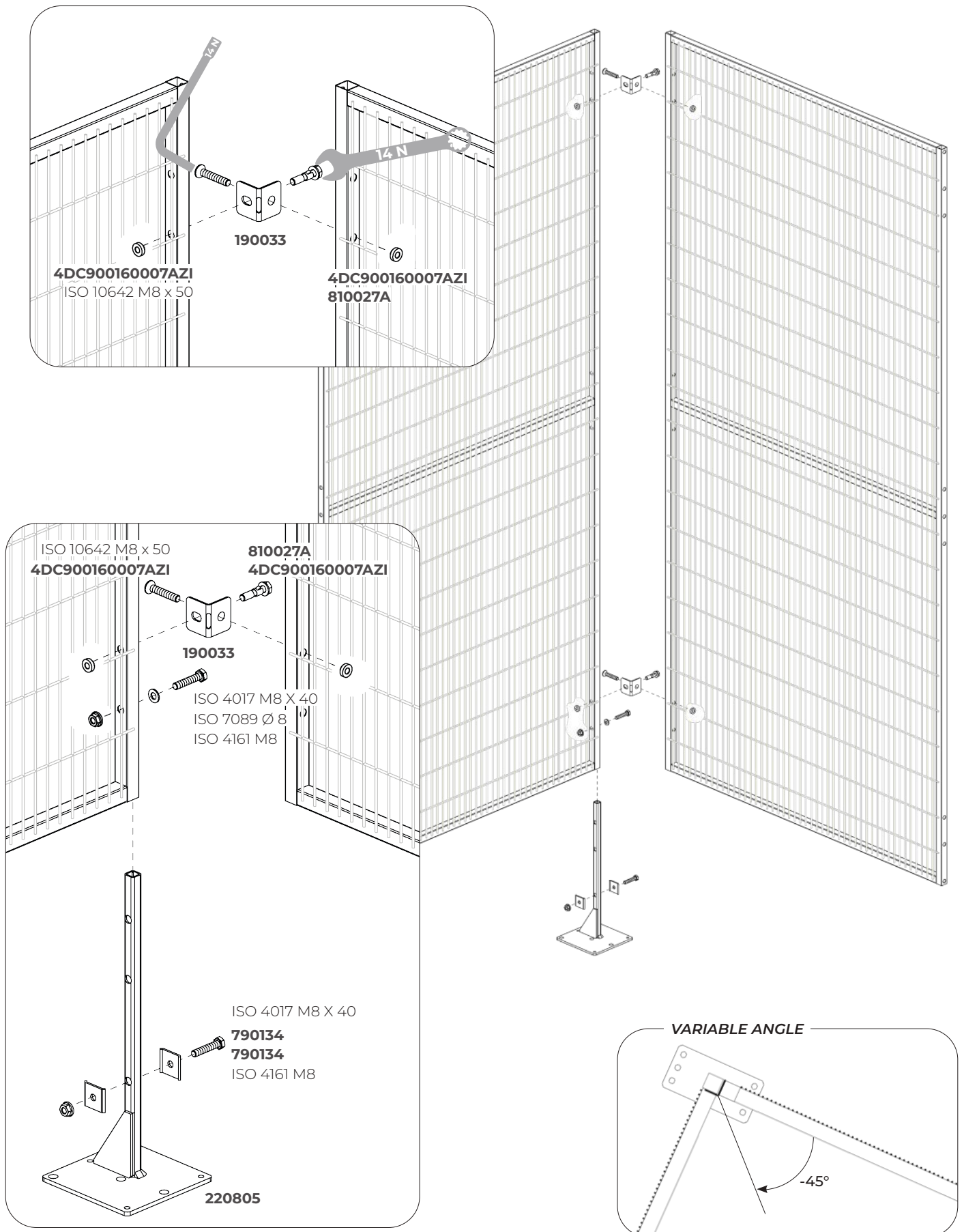

Modular Machine Guards that fit your needs.

Tailor-made solutions for the safety of operators and machinery



Protecting workers and machinery is paramount to create a safe and productive work environment. Satech Modular Machine Guards Systems, Doors and Accessories provide tailor-made solutions for any machinery layout need. **3 framed Systems, 2 frameless Systems and more than 150 Locks/Interlocks** ensure the maximum level of protection (PL) when accessing hazard areas for inspection or machinery maintenance.

Perimeter Protection Machine Safety Guards compliant with European and International Standards

Satech Machine Guards are manufactured in compliance with the **EN ISO 14120** standard, "General requirements for the design and construction of fixed and movable guards". They can be installed at a minimum distance of **120 mm from hazard** (as for EN ISO 13857), saving you plenty of layout space.

All Satech products are manufactured with **quality materials** and are highly durable. Mesh panels and other panel solutions can be easily and rapidly connected to posts (with captive retained fastenings, as for 2006/42/CE - Machinery Directive), which allows you to greatly **reduce assembly time**.

Founded in 2000, Satech was the first Italian Perimeter Guards Manufacturer. A **modern international company** today, in our 20+ years of work we have taken care of the safety of thousands of automated machinery systems and of millions of people worldwide. A **Safe Factory** is a **Productive One**.



Need help with this manual?

If you need additional specs, tips or manuals, please call our **Customer Service** at

+39 031 86230 85

SATECH
Modular Machine Guards

Satech Safety Technology SpA

Via Conte Taverna, 1
I-23892 Bulciago (LC)
Phone +39 031 86230 11



CERTIFIED
ISO 9001
ISO 14001
ISO 45001

