

# FastGuard 30

H1620mm ASSEMBLY INSTRUCTIONS

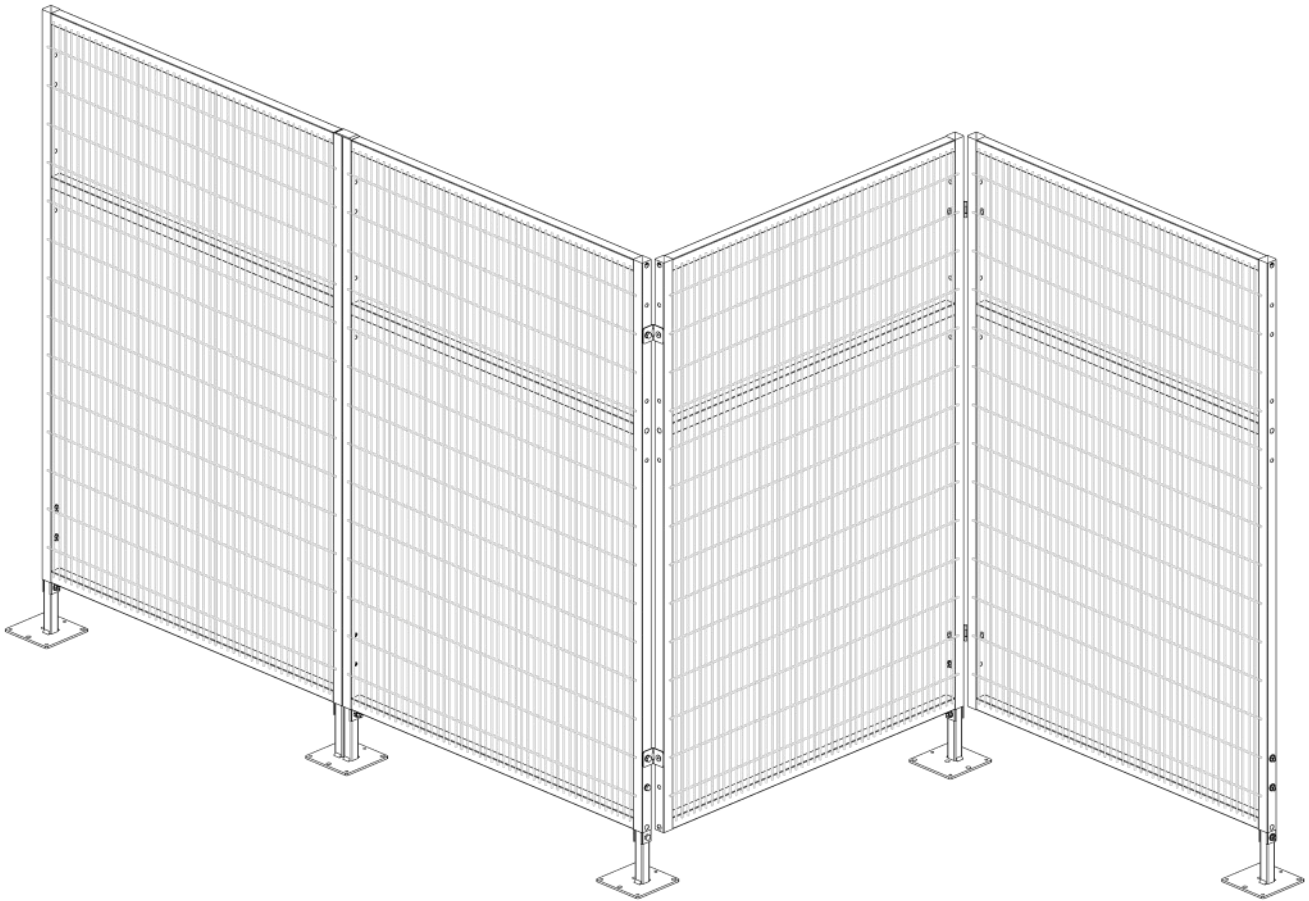
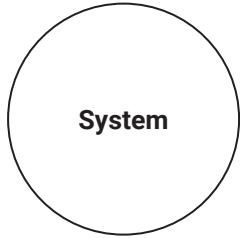

# FastGuard 30

SAFE START

1

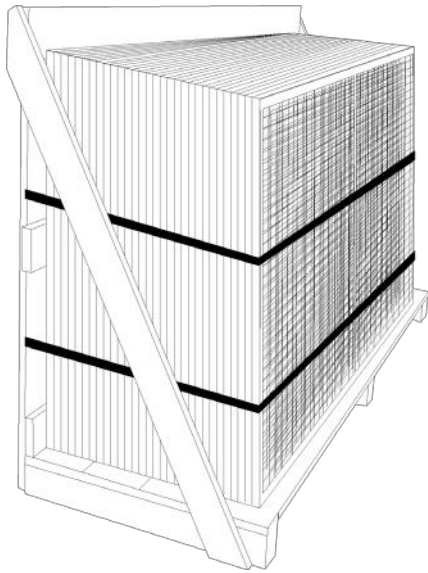

2

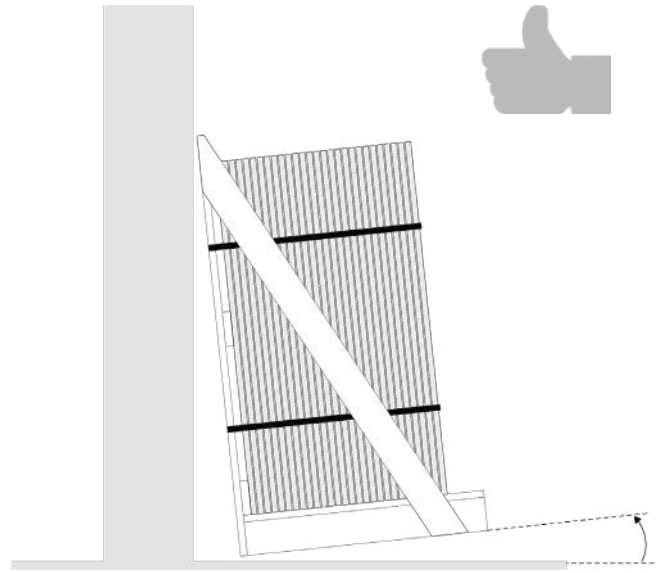

3

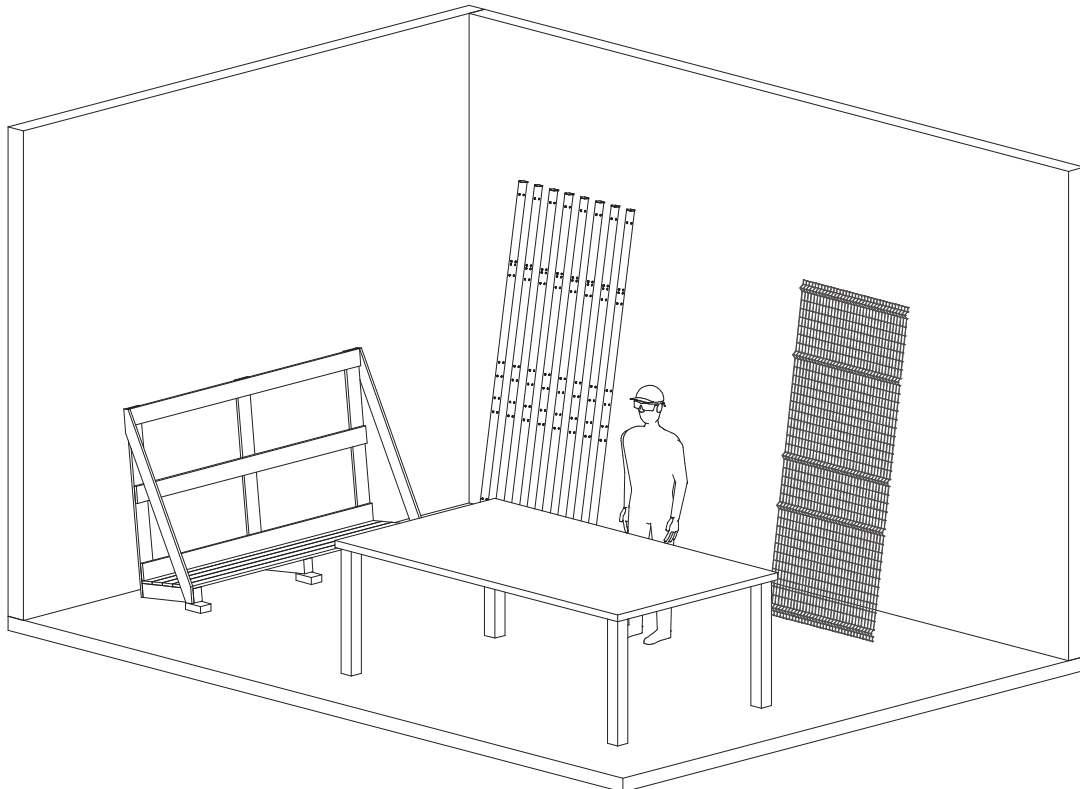

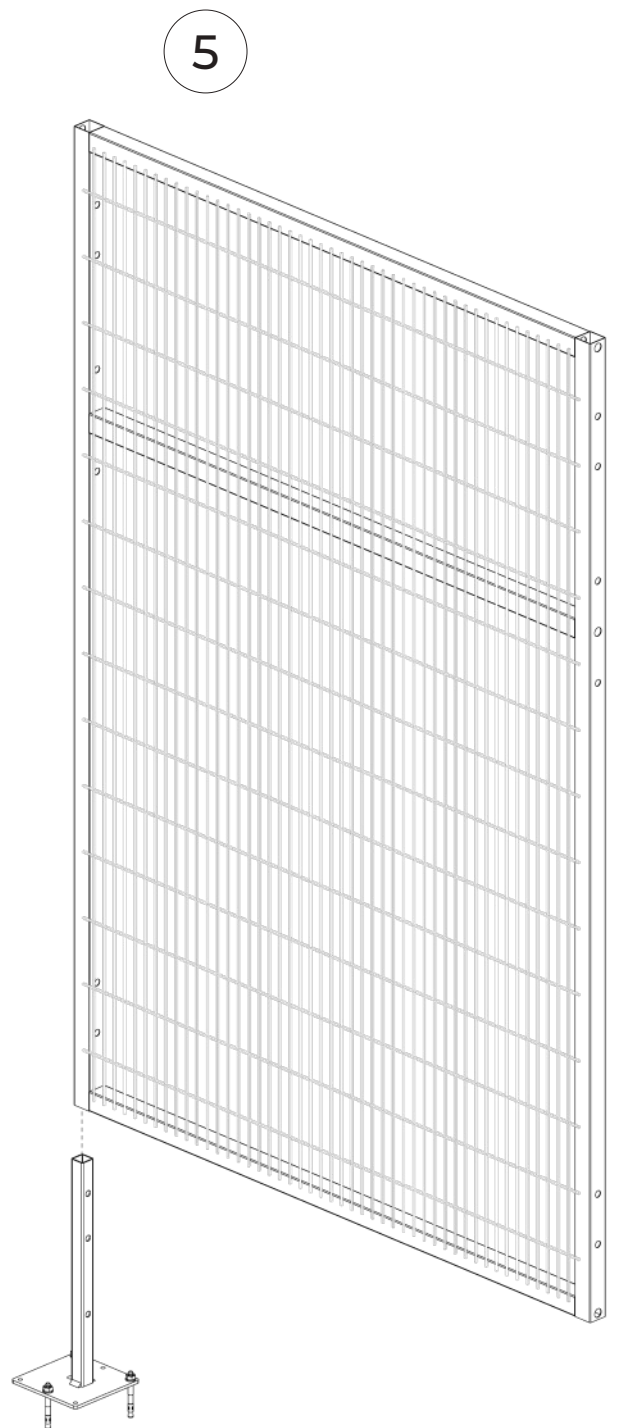
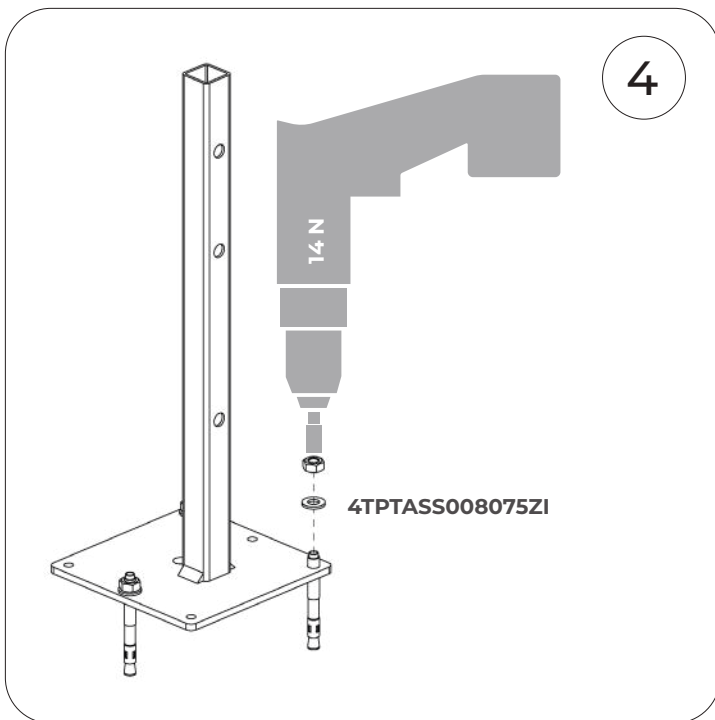

# FastGuard 30

H1620mm ASSEMBLY INSTRUCTIONS - LINEAR

## 40210000000001

ISO 4017 M8 X 30

ISO 7089 Ø 8

4TPTASS008075ZI

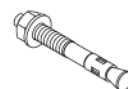

x 1

x 1

x 3

## 402100000000013

790134

4VEZTFZA008080

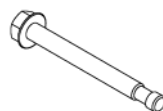

x 2

x 1

490042D

4VEZE11AB08070A

4DC900160007AZI

4DAD40B000008ZI

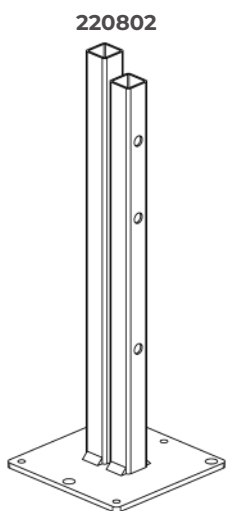

220802



x 1

x 1

x 1

x 1

x 1

### Tools

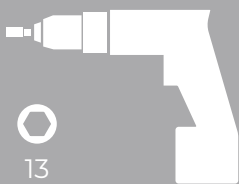

13



13

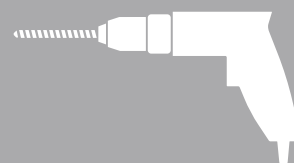

# FastGuard 30

H1620mm ASSEMBLY INSTRUCTIONS - LINEAR

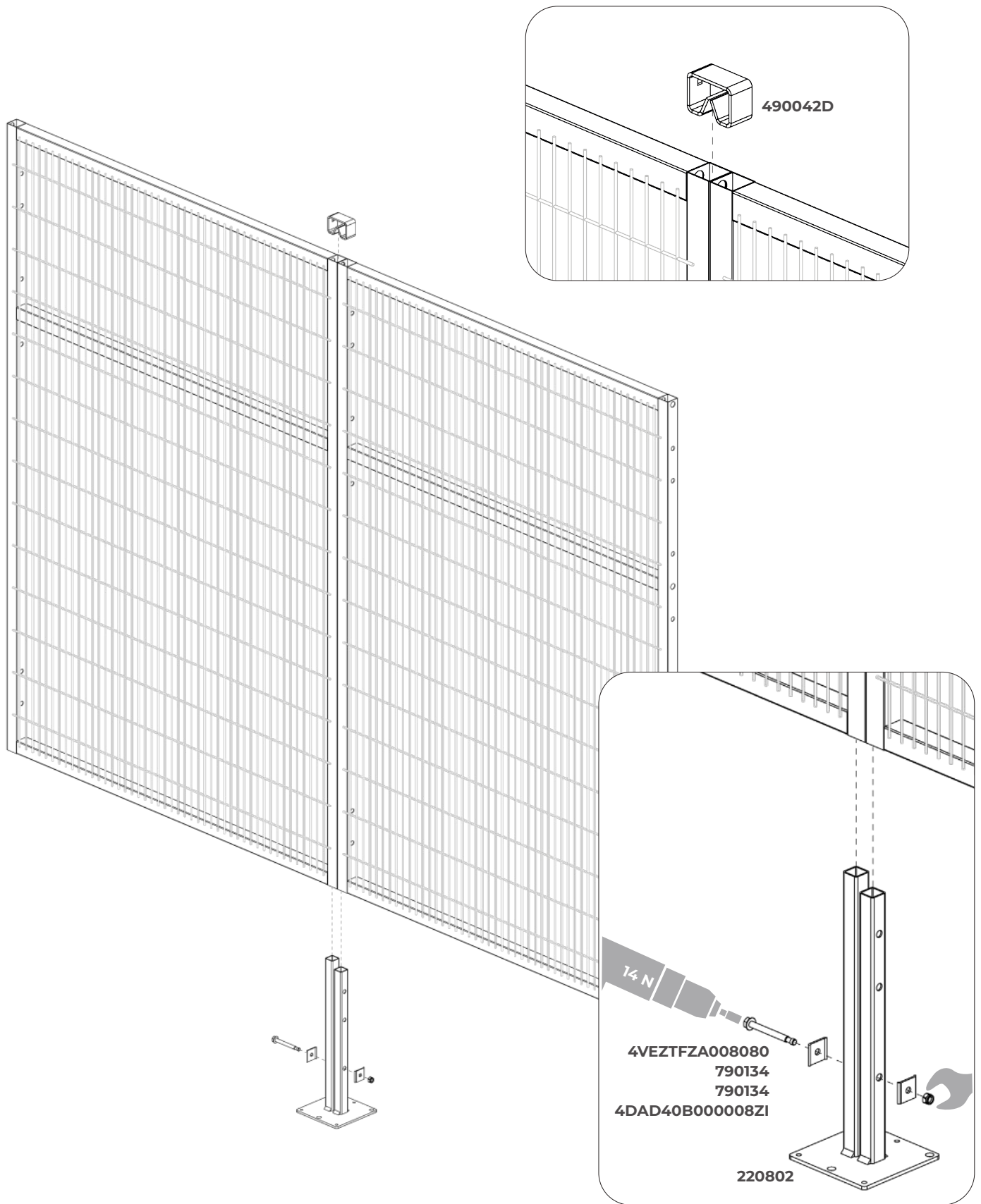

# FastGuard 30

H1620mm ASSEMBLY INSTRUCTIONS - TERMINAL

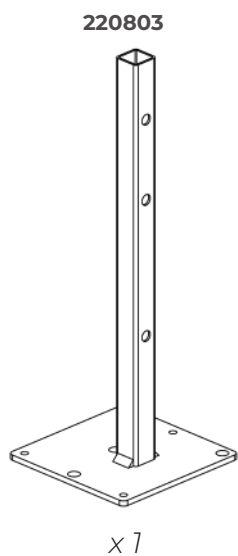

## 402100000000001

ISO 4017 M8 X 30



x1

ISO 7089 Ø 8



x1

4TPTASS008075Z1

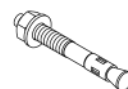

x3

## 402100000000011

790134



x2

ISO 4017 M8 X 40



x3

ISO 7089 Ø 8



x3

ISO 4161 M8



x3

## Tools

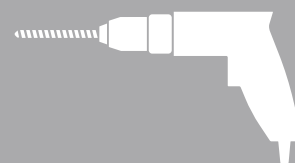
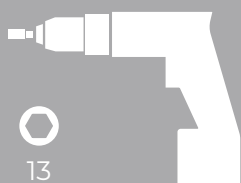

# FastGuard 30

H1620mm ASSEMBLY INSTRUCTIONS - TERMINAL

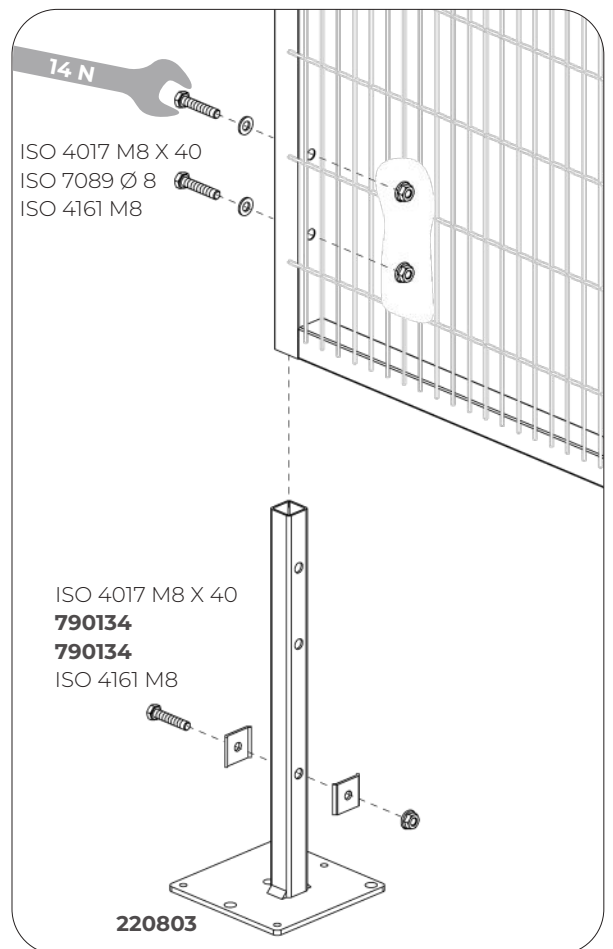
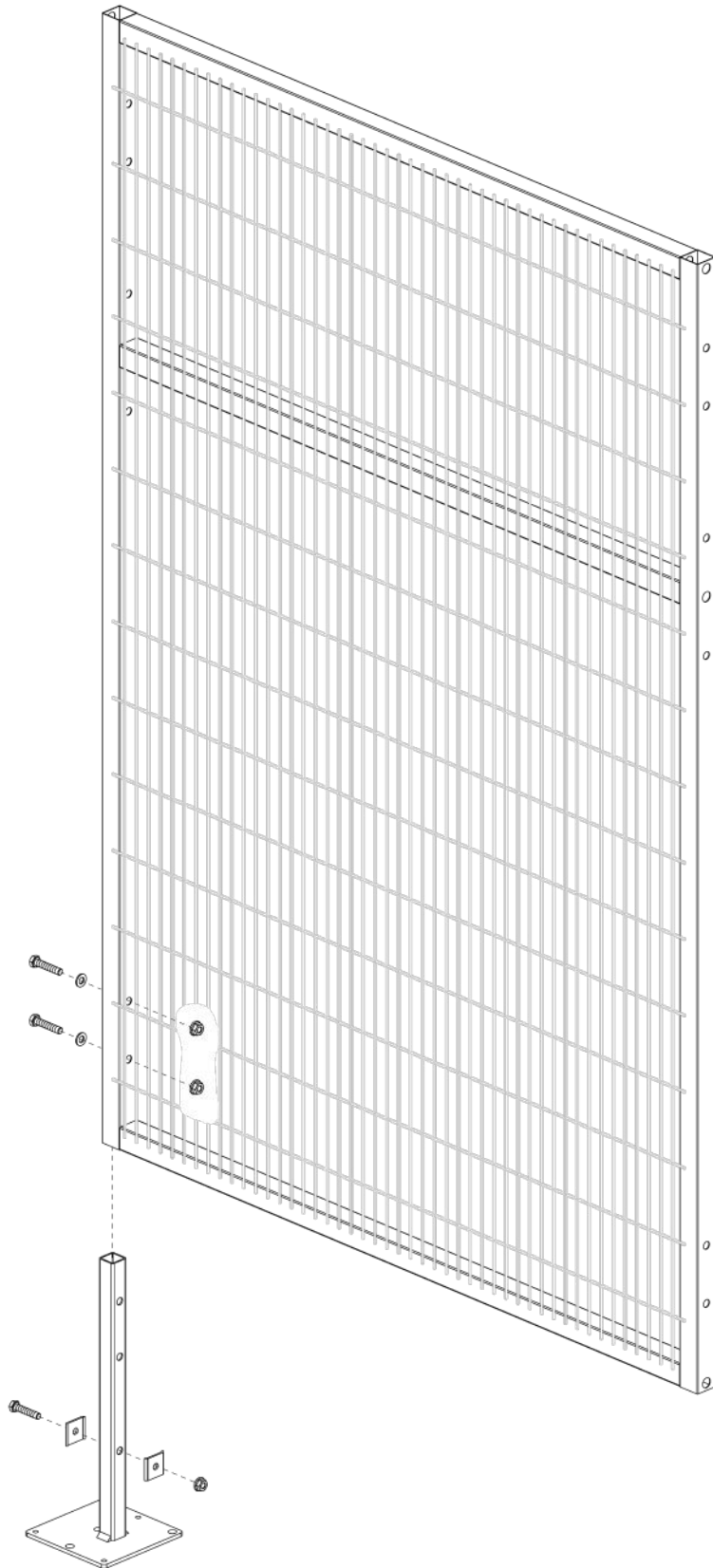

# FastGuard 30

H1620mm ASSEMBLY INSTRUCTIONS - ANGULAR / VARIABLE ANGLE

## 4021000000000001

ISO 4017 M8 X 30



x 1

ISO 7089 Ø 8



x 1

4TPTASS008075Z1



x 3

## 4021000000000010

190033

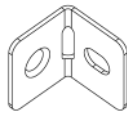

x 2

4DC900160007AZI



x 4

810031



x 2

ISO 10642 M8 x 50



x 4

## 4021000000000011

790134



x 2

ISO 4017 M8 X 40



x 3

ISO 7089 Ø 8



x 3

ISO 4161 M8



x 3

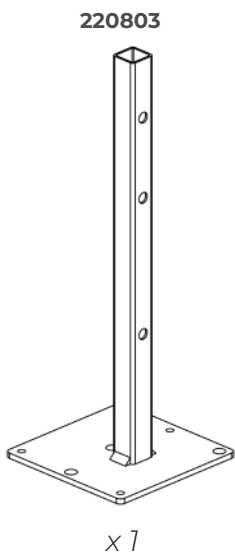

### Tools

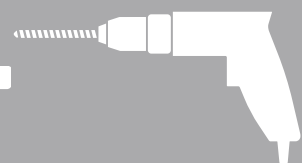
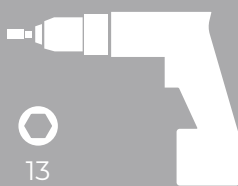



# FastGuard 30

H1620mm ASSEMBLY INSTRUCTIONS - ANGULAR / VARIABLE ANGLE

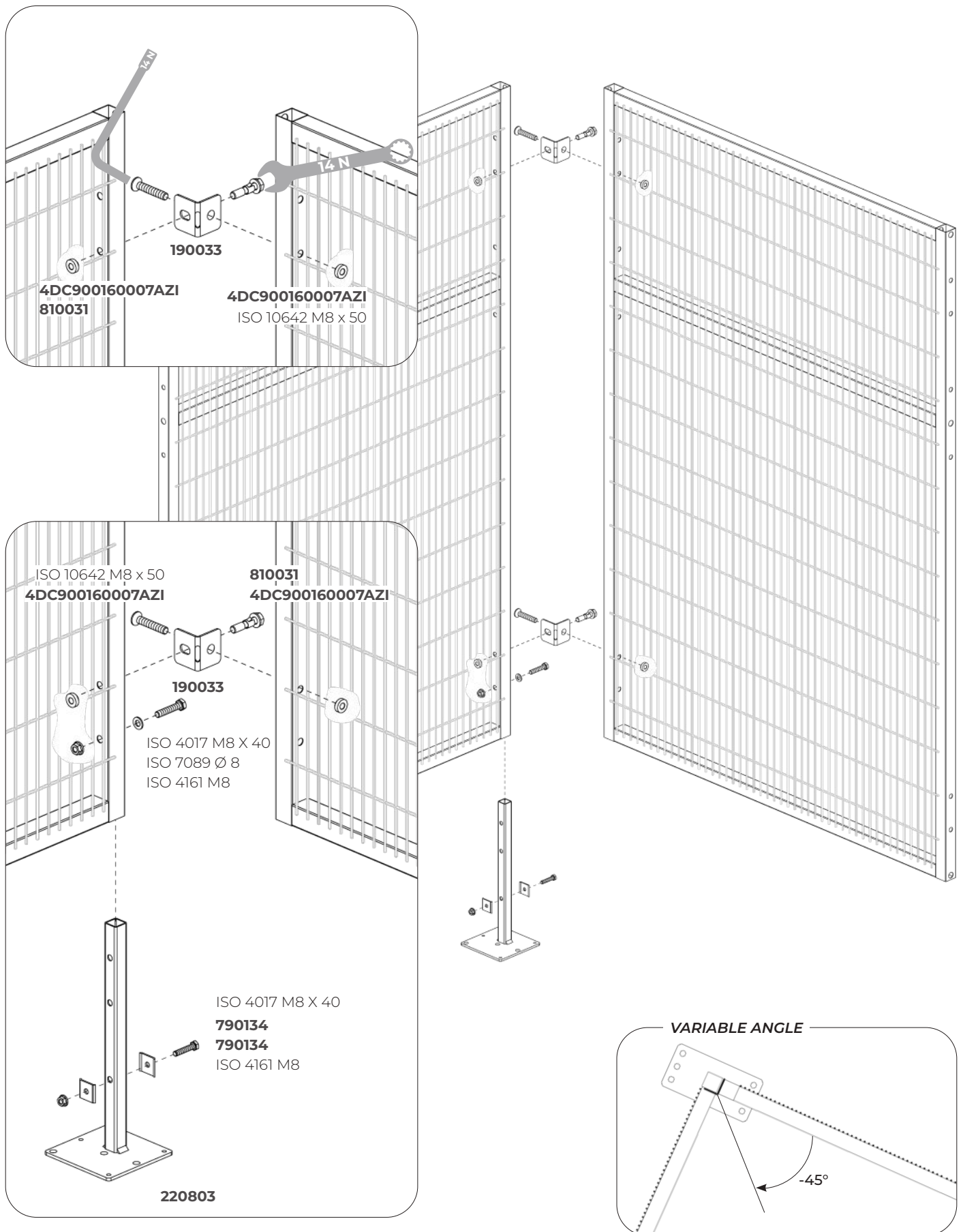

# FastGuard 30

H2220/2620mm ASSEMBLY INSTRUCTIONS

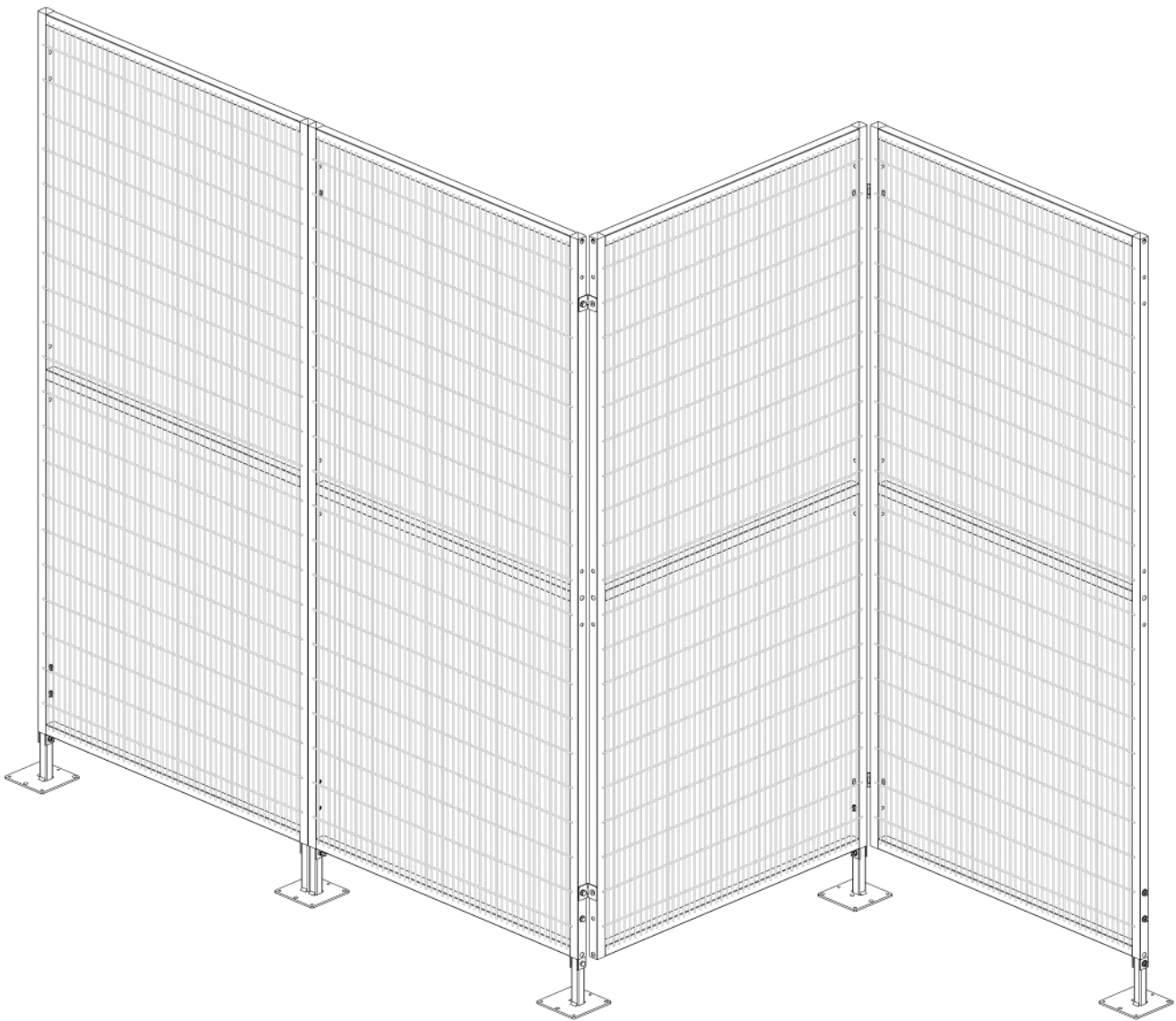
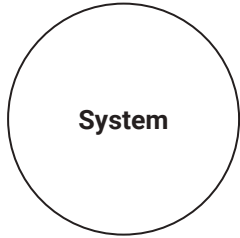

# FastGuard 30

SAFE START

1

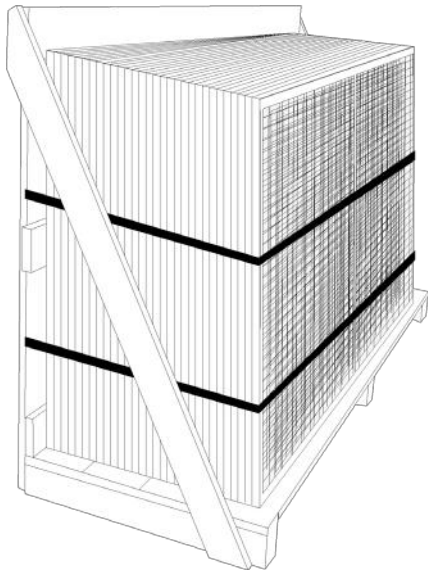

2

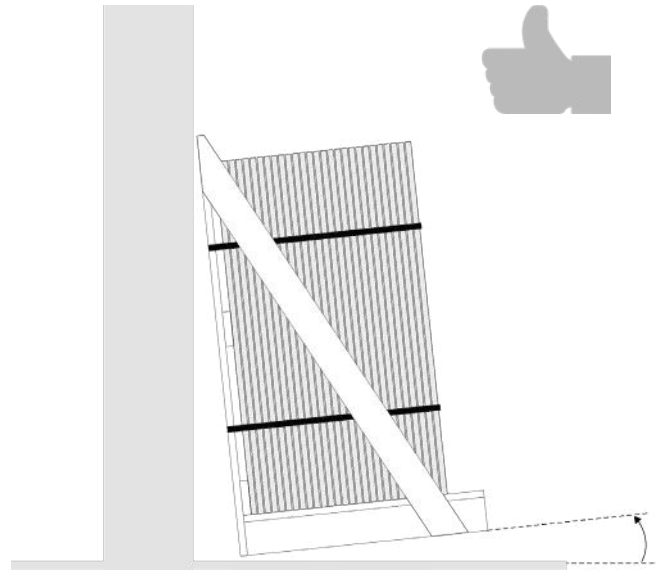

3

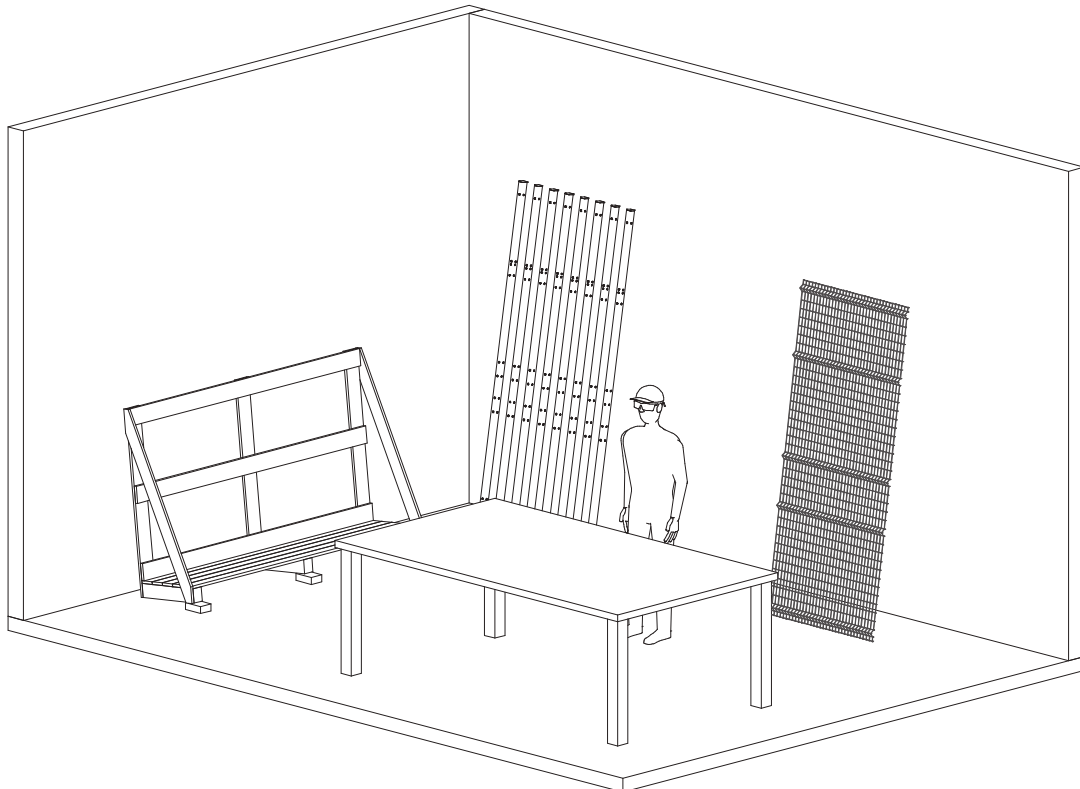

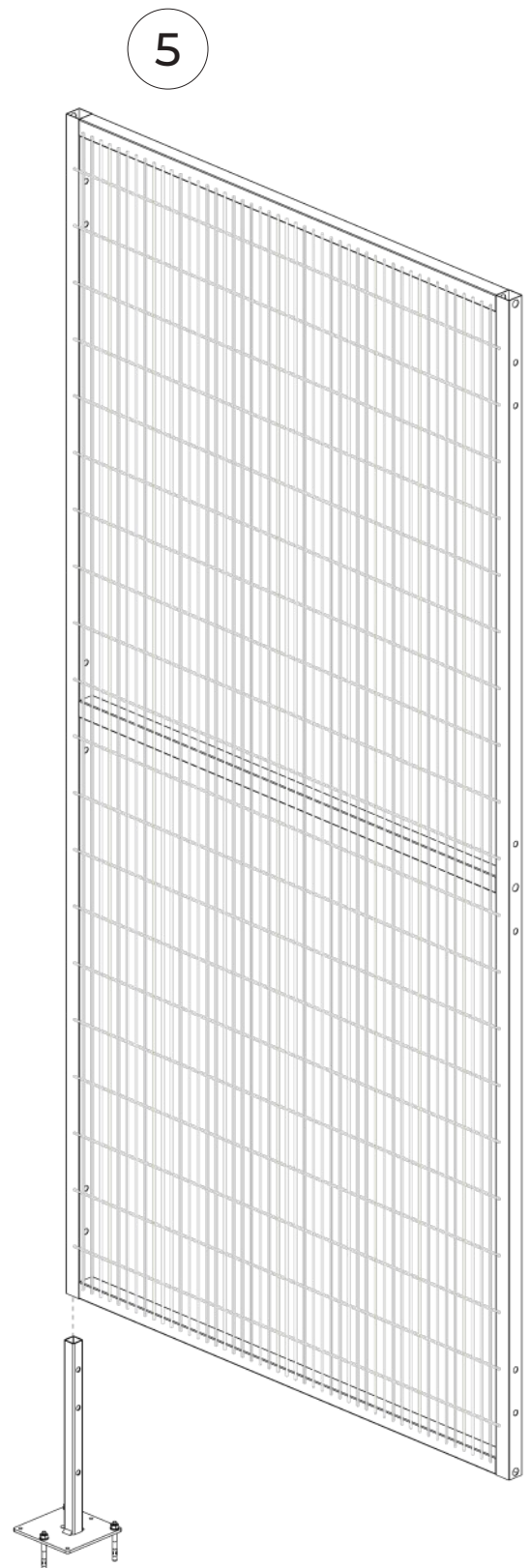
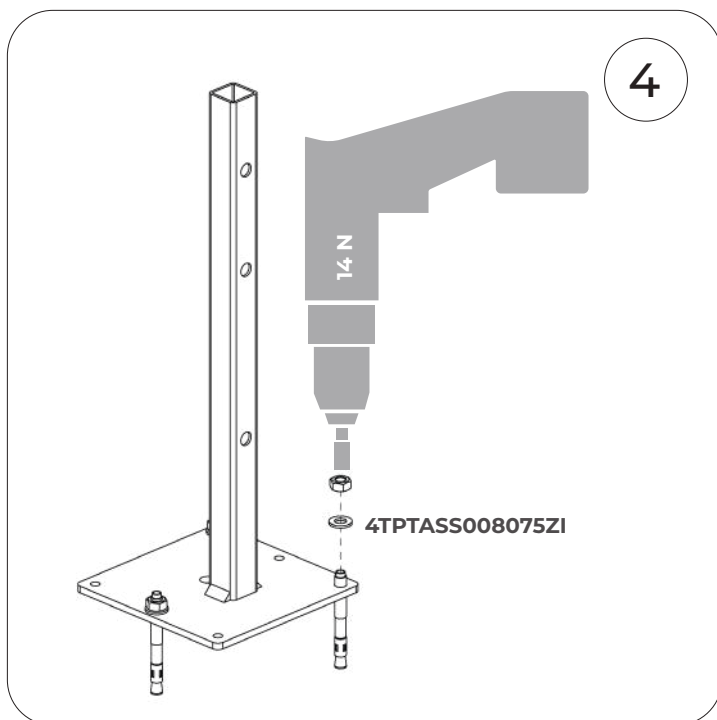

# FastGuard 30

H2220/2620mm ASSEMBLY INSTRUCTIONS - LINEAR

## 402100000000001

ISO 4017 M8 X 30



x 1

ISO 7089 Ø 8



x 1

4TPTASS008075ZI

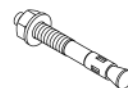

x 3

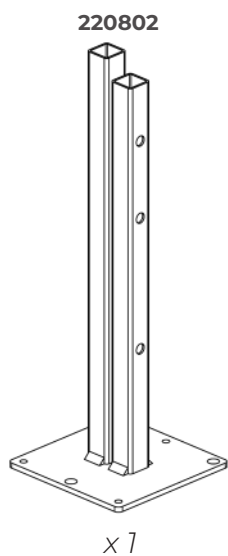

## 402100000000013

790134



x 2

4VEZTFZA008080

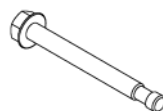

x 1

4VEZE11AB08070A



x 1

4DC900160007AZI



x 1

4DAD40B000008ZI



x 1

### Tools

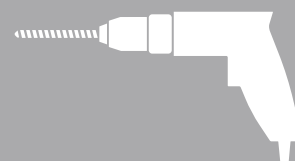
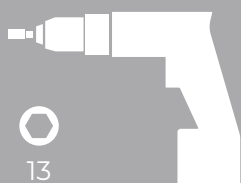

# FastGuard 30

H2220/2620mm ASSEMBLY INSTRUCTIONS - LINEAR

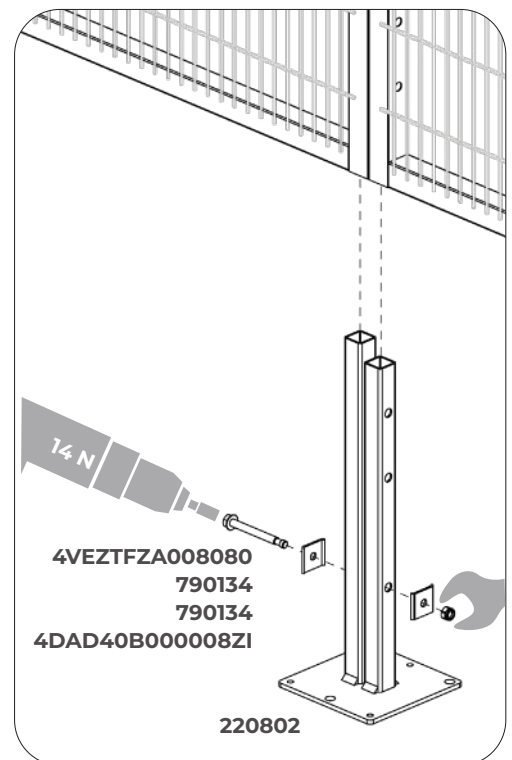
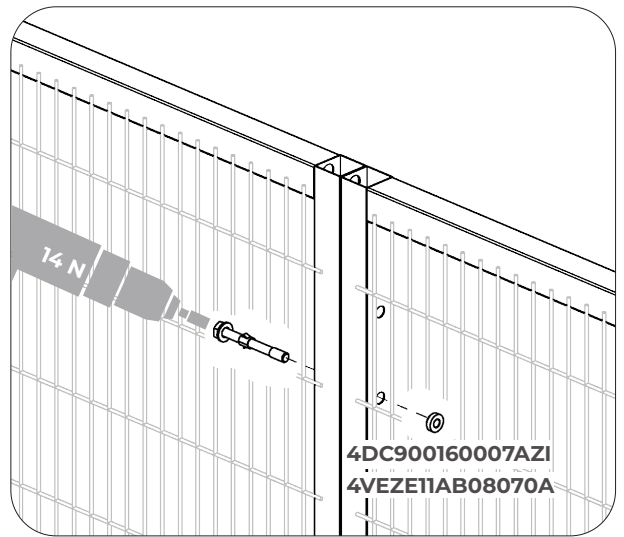
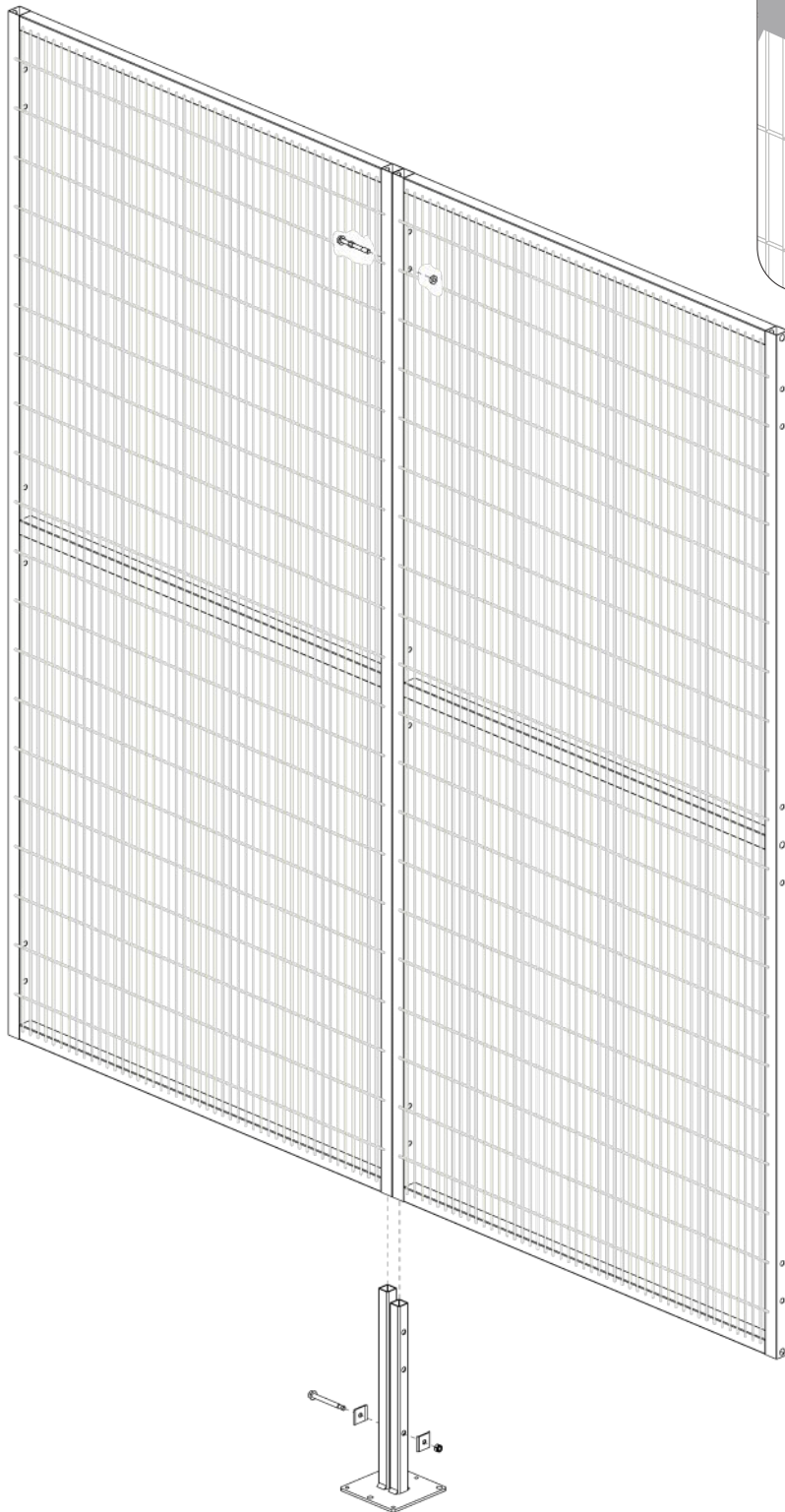

# FastGuard 30

H2220/2620mm ASSEMBLY INSTRUCTIONS - TERMINAL

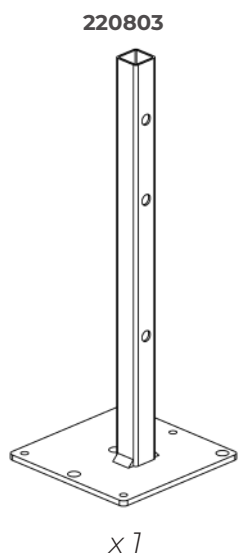

## 402100000000001

ISO 4017 M8 X 30



x1

ISO 7089 Ø 8



x1

**4TPTASS008075Z1**

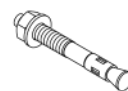

x3

## 4021000000000011

**790134**

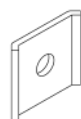

x2

ISO 4017 M8 X 40



x3

ISO 7089 Ø 8



x3

ISO 4161 M8



x3

## Tools

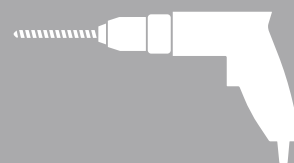
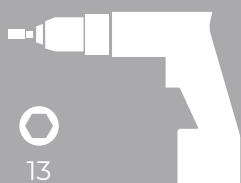

# FastGuard 30

H2220/2620mm ASSEMBLY INSTRUCTIONS - TERMINAL

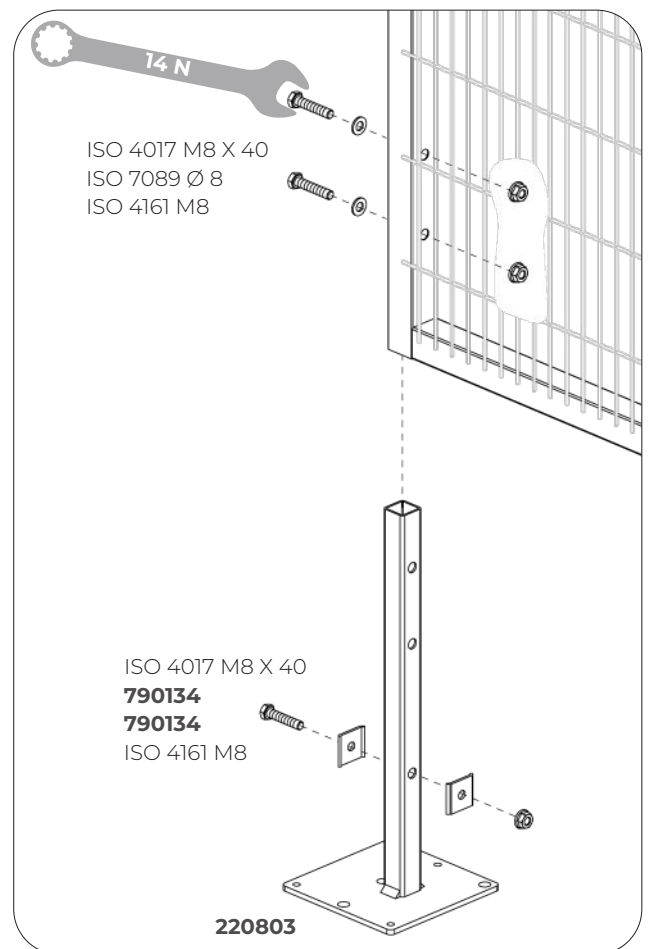
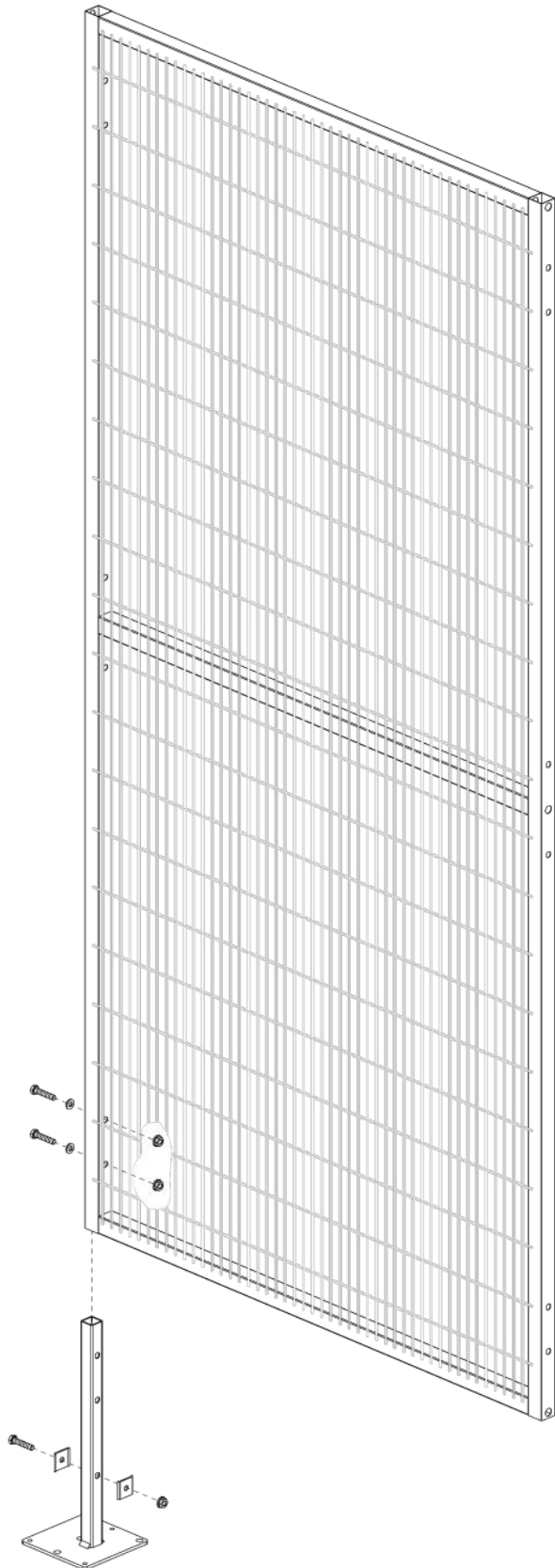



# FastGuard 30

H2220/2620mm ASSEMBLY INSTRUCTIONS - ANGULAR / VARIABLE ANGLE

## 4021000000000001

ISO 4017 M8 X 30



x 1

ISO 7089 Ø 8



x 1

4TPTASS008075ZI



x 3

## 4021000000000010

190033

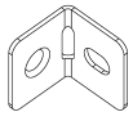

x 2

4DC900160007AZI



x 4

810031



x 2

ISO 10642 M8 x 50



x 4

## 4021000000000011

790134



x 2

ISO 4017 M8 X 40



x 3

ISO 7089 Ø 8



x 3

ISO 4161 M8



x 3

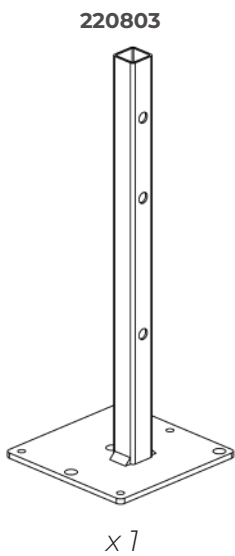

### Tools

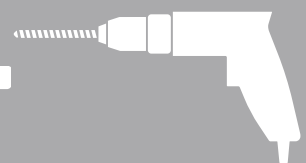
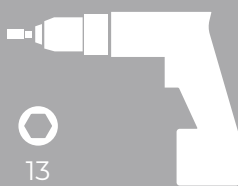

# FastGuard 30

## H2220/2620mm ASSEMBLY INSTRUCTIONS - ANGULAR / VARIABLE ANGLE

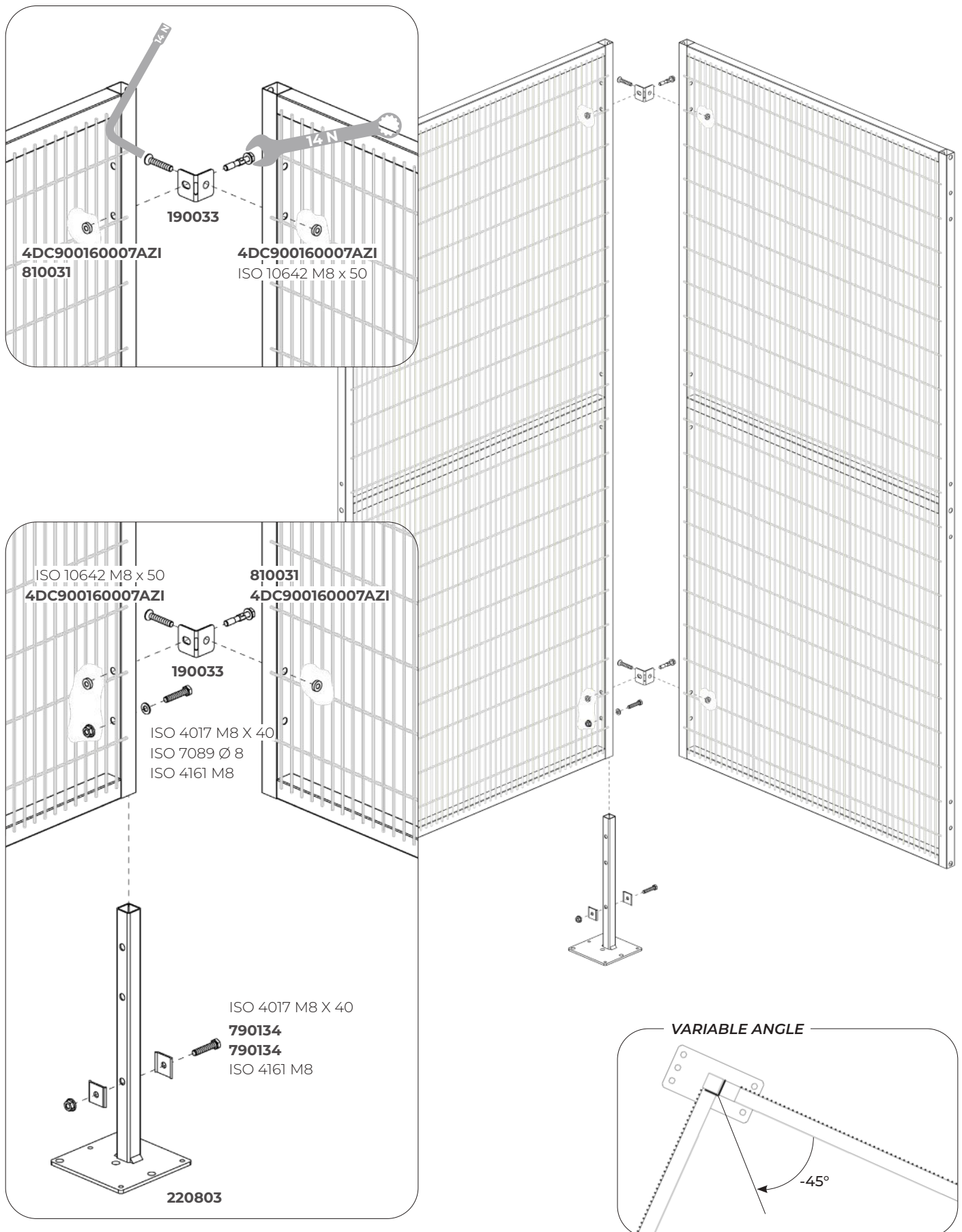

# Modular Machine Guards that fit your needs.

Tailor-made solutions for the safety of operators and machinery



Protecting workers and machinery is paramount to create a safe and productive work environment. Satech Modular Machine Guards Systems, Doors and Accessories provide tailor-made solutions for any machinery layout need. **3 framed Systems, 2 frameless Systems and more than 150 Locks/Interlocks** ensure the maximum level of protection (PL) when accessing hazard areas for inspection or machinery maintenance.

## Perimeter Protection Machine Safety Guards compliant with European and International Standards

Satech Machine Guards are manufactured in compliance with the **EN ISO 14120** standard, "General requirements for the design and construction of fixed and movable guards". They can be installed at a minimum distance of **120 mm from hazard** (as for EN ISO 13857), saving you plenty of layout space.

All Satech products are manufactured with **quality materials** and are highly durable. Mesh panels and other panel solutions can be easily and rapidly connected to posts (with captive retained fastenings, as for 2006/42/CE - Machinery Directive), which allows you to greatly **reduce assembly time**.

Founded in 2000, Satech was the first Italian Perimeter Guards Manufacturer. A **modern international company** today, in our 20+ years of work we have taken care of the safety of thousands of automated machinery systems and of millions of people worldwide. A **Safe Factory** is a **Productive One**.



## Need help with this manual?

If you need additional specs, tips or manuals, please call our **Customer Service** at

**+39 031 86230 85**

**SATECH**  
Modular Machine Guards

Satech Safety Technology SpA

Via Conte Taverna, 1  
I-23892 Bulciago (LC)  
Phone +39 031 86230 11



**CERTIFIED**  
**ISO 9001**  
**ISO 14001**  
**ISO 45001**

